

Run-on and Run-off Control System Plan

Public Service Company of Oklahoma
Northeastern Power Station Ash Landfill

Non-Hazardous Industrial Waste (NHIW) Landfill

Permit No. FA3566010
September 17, 2021

Terracon Project No. 35217182



An **AEP** Company

BOUNDLESS ENERGYSM

Prepared for:

American Electric Power
1 Riverside Plaza
Columbus, Ohio 43215
(614) 716-1000

Prepared by:

Terracon Consultants, Inc.
25809 Interstate 30 South
Bryant, Arkansas 72022
(501) 847-9292

terracon.com

Terracon

Environmental



Facilities



Geotechnical



Materials

Table of Contents

1.0 - Introduction	1
2.0 - Run-on Controls	2
2.1 Run-On Control Outside the Landfill Footprint.....	2
2.2 Run-On Control Inside the Landfill Footprint	3
2.2.1 Cell 1 Active Filling Area	3
3.0 - Run-off Controls	4
3.1 Perimeter Containment Berms.....	4
3.2 Leachate Collection System	4
3.3 Conveyance Piping to Leachate Impoundment.....	5
3.4 Leachate Impoundment.....	5
3.5 Ash Filling Operation	5
4.0 - Plan Review and Changes in Facility Configuration.....	5
5.0 - Professional Engineer Certification.....	6

APPENDIX 1: FIGURES

Figure 1 – *Site Layout Map*

Figure 2 – *Stormwater Management Plan*

Figure 3 – *Miscellaneous Details*

Figure 4 – *Stormwater Management Details*

Figure 5 – *Current Fill Area*

APPENDIX 2: STORMWATER CALCULATIONS FROM PERMIT MODIFICATION

APPENDIX 3: PLAN REVIEW LOG

APPENDIX 4: PROFESSIONAL ENGINEER CERTIFICATION PAGE

1.0 - Introduction

OAC 252:517-13-2 requires the owner or operator of an existing or new CCR (Coal Combustion Residual) landfill or any lateral expansion of a CCR landfill must design, construct, operate and maintain:

(a) **Run-on/run-off control systems.** The owner or operator of an existing or new CCR landfill or any lateral expansion of a CCR landfill must design, construct, operate, and maintain:

- (1) A run-on control system to prevent flow onto the active portion of the CCR unit during the peak discharge from a 24-hour, 25-year storm; and
- (2) A run-off control system from the active portion of the CCR unit to collect and control at least the water volume resulting from a 24-hour, 25-year storm.

(b) **Run-off from active portion of CCR unit.** Run-off from the active portion of the CCR unit must be handled in accordance with the surface water requirements under OAC 252:517-13-6.

(c) **Run-on and run-off control system plan.**

(1) **Content of the plan.** The owner or operator must prepare initial and periodic run-on and run-off control system plans for the CCR unit according to the timeframes specified in paragraphs (c)(3) and (4) of this Section. These plans must document how the run-on and run-off control systems have been designed and constructed to meet the applicable requirements of this Section. Each plan must be supported by appropriate engineering calculations. The owner or operator has completed the initial run-on and run-off control system plan when the plan has been placed in the facility's operating record as required by OAC 252:517-19-1(g)(3).

(2) **Amendment of the plan.** The owner or operator may amend the written run-on and run-off control system plan at any time provided the revised plan is placed in the facility's operating record as required by OAC 252:517-19-1(g)(3). The owner or operator must amend the written run-on and run-off control system plan whenever there is a change in conditions that would substantially affect the written plan in effect.

(3) **Timeframes for preparing the initial plan.**

(A) **Existing CCR landfills.** The owner or operator of the CCR unit must prepare the initial run-on and run-off control system plan no later than October 17, 2016.

(B) **New CCR landfills and any lateral expansion of a CCR landfill.** The owner or operator must prepare the initial run-on and run-off control system plan no later than the date of initial receipt of CCR in the CCR unit.

(4) **Frequency for revising the plan.** The owner or operator of the CCR unit must prepare periodic run-on and run-off control system plans required by paragraph (c)(1) of this Section every five years. The date of completing the initial plan is the basis for establishing the deadline to complete the first subsequent plan. The owner or operator may complete any required plan prior to the required deadline provided the owner or operator places the completed plan into the facility's operating record within a reasonable amount of time. In all

cases, the deadline for completing a subsequent plan is based on the date of completing the previous plan. For purposes of this paragraph (c)(4), the owner or operator has completed a periodic run-on and run-off control system plan when the plan has been placed in the facility's operating record as required by OAC 252:517-19-1(g)(3).

(5) **PE certification.** The owner or operator must obtain a certification from a qualified professional engineer stating that the initial and periodic run-on and run-off control system plans meet the requirements of this Section.

(6) **DEQ approval required.** The owner or operator must submit the initial and periodic run-on and run-off control system plans, and any subsequent amendment of the plans, to the DEQ for approval.

(d) **Recordkeeping.** The owner or operator of the CCR unit must comply with the recordkeeping requirements specified in OAC 252:517-19-1(g), the notification requirements specified in OAC 252:517-19-2(f), and the internet requirements specified in OAC 252:517-19-3(g).

As part of the Oklahoma Department of Environmental Quality (ODEQ) Tier II permit modification for Permit No. FA3566010, a detailed engineering analysis was performed on the components that comprise the stormwater system. This included a hydrologic analysis of the Landfill area which was analyzed using Technical Reference 55 (WinTR-55) software from the Natural Resources Conservation Service (See **APPENDIX 2**).

Landfill operations have installed and are currently maintaining many of the planned stormwater control measures discussed in this plan. Attached **FIGURE 1 – Site Layout Map** in **APPENDIX 1** illustrates the general layout of the NHIW Landfill and the Stormwater Run-Off Pond (Basin C).

2.0 - Run-on Controls

The run-on control system designed to prevent flow onto the active portion of the landfill during the peak discharge from a 24-hour, 25-year storm, must consider site conditions around the landfill, outside of the landfill footprint, as well as site conditions within the landfill footprint.

2.1 Run-On Control Outside the Landfill Footprint

Built up perimeter berms/dikes with roadways around the landfill perimeter provide controls to prevent run-on from outside the landfill footprint and perimeter roads. Because the area around the landfill is reasonably well-drained away from the landfill, there is limited potential for stormwater drainage directed toward the landfill. Perimeter drainage channels inside the diked area were designed to handle the run-off from the operating and then closed landfill areas as their primary purpose. These perimeter channels are currently constructed, along with perimeter containment berms that define the limits of the landfill ash disposal area/footprint. The perimeter channels (see **FIGURE 2**), direct flow to the northeast end of the landfill to the stormwater pond - Basin C. Discharges of stormwater collected in Basin C of the landfill are managed as part of the facility Oklahoma Pollutant Discharge Elimination System (OPDES) program.

Surface water drainage calculations were performed to adequately size the side-slope benches and down-slope channels that are incorporated into the final grades, and the perimeter channels around the landfill footprint. Storm water drainage calculations used a 24-hour, 25-year storm event to generate storm water run-off from a vegetated final grade surface. The details of the different stormwater systems can be found on **FIGURE 3 and FIGURE 4**.

A perimeter drainage channel system handles storm water run-off flow from the down-slope channels and the final cover cap. The perimeter channels have a trapezoidal shape that was modeled to handle the 24-hour, 25-year storm event. The channels are sloped to drain into Basin C to the northeast of the landfill.

2.2 Run-On Control Inside the Landfill Footprint

The Northeastern Ash Landfill was retrofitted with a compacted fly ash and geomembrane liner and leachate collection system over existing wastes. Four cells were created on top of the interim liner system for waste deposition with collection of leachate. The whole prepared area is surrounded by a minimum five-foot high perimeter berm and the cells are separated by inter-cell berms. Within the landfill footprint, limited operational run-on controls are used during filling.

Current fill operations have utilized the initial prepared cell (Cell 2) and parts of the northeastern portion of Cell 1. Run-on controls are utilized to prevent stormwater contact with waste filling areas as detailed below and as presented on attached **FIGURE 5**. Additionally, the landfill intends to cover the current fill area in Cell 2 along with Cells 3 and 4 with temporary rain blanket geomembrane panels to inhibit the infiltration of leachate and erosion of existing materials.

The current fill plan results in utilizing specific prepared areas to accept CCRs while other areas have been prepared to divert stormwater run-off using a system of berms, temporary rain blankets, and temporary weirs along the landfill perimeter berm to allow run-off water to be directed into the perimeter stormwater ditches. All fill phases will incorporate containment berms that are either permanent berms or temporary internal berms to control run-off and run-on in the operating area.

2.2.1 Cell 1 Active Filling Area

Cell 1 filling began in the mid-portion of Cell 1, tying in with Cell 2 and progressing to the southwest. Local run-on controls within the landfill cells are provided by the cells' perimeter berms. The exterior storm water is directed into the perimeter graded drainage channels on all sides of Cells 1, 2, 3, and 4 and will then be directed to the northeast side of the landfill into Basin C. The stormwater entering the landfill on the west side of Cell 1 will drain to the northeast portion and then over temporary weirs into the perimeter stormwater ditch, diverting run-on stormwater into Basin C. The stormwater entering the landfill west of Cell 2 drains south of Cells 3 and 4, through the weir openings, and into the perimeter stormwater ditch, conveying non-contact run-on stormwater into Basin C (see **FIGURE 5**).

3.0 - Run-off Controls

The run-off control system to prevent flow (contact water) from leaving the active portion of the landfill during the peak discharge from a 24-hour, 25-year storm considers site conditions within the active filling areas. Run-off control consists of the following aspects:

- Perimeter containment berms
- Leachate collection system (LCS)
- Leachate disposal system
- Ash filling operation

Perimeter containment berms are provided around the active filling area to control run-on as discussed above, but also serve to control run-off. The perimeter berms incorporate temporary weir openings that will be closed and lined with geomembrane once waste filling occurs in the weir areas. The landfill includes a collection system for contact water that percolates through the waste (referred to as the leachate collection system) that is comprised of a composite drainage layer and perforated collection piping which are part of the landfill intermediate liner system. Collected percolated water is managed by a collection system, the leachate collection pipes, conveyance piping, a lined leachate storage impoundment, and a final regulated discharge outlet. The ash filling operation is managed such that contact water is directed to the collection system features. Details of the run-off control features are presented on the attached **FIGURES 3 and 4**. The following further describes the run-off control components.

3.1 Perimeter Containment Berms

The perimeter containment berms are constructed around the active-phase filling areas. These berms serve to contain the limits of active ash filling and provide a barrier and collection point for run-off control. The leachate collection system and ash filling operation use the berms as part of their control systems as described below.

3.2 Leachate Collection System

The leachate collection system consists of a geocomposite drainage layer overlying the HDPE geomembrane liner with a minimum of approximately 1.4 percent slope to the leachate collection trenches, and a 2-ft. thick drainage layer/protective cover over the landfill floor and 1-ft. thick layer over the slopes. The LCS piping consists of 12-inch diameter perforated HDPE SDR-26 collection piping wrapped in a gravel protective/drainage envelope and will gravity drain at an approximate minimum slope of 0.5 percent. The composite liner system and leachate collection pipe network slope to low points trenched along the interior of the perimeter containment berms, where the collected run-off flows into conveyance pipes for the leachate system. The leachate collection pipe network spacing is a function of the base grade liner slope, drainage layer permeability, and flow distance to collection pipes. The Hydraulic Evaluation of Landfill Performance (HELP) model and Flowmaster (Haestad Methods, Inc.) were used in evaluating the pipe spacing with respect

to contact water percolation to the leachate collection drainage layer, the minimum liner slope and a flow distance to the collection piping.

3.3 Conveyance Piping to Leachate Impoundment

The leachate collection system drains toward the northeastern perimeter of the landfill area where the pipes penetrate the landfill liner and continue to drain into the leachate impoundment. The pipes conveying leachate from the landfill into the leachate impoundment are 12-inch-diameter Solid HDPE SDR-26 pipe. The conveyance pipes slope at a minimum 1% slope or greater toward the leachate impoundment.

3.4 Leachate Impoundment

The leachate impoundment is on the northeastern side of the landfill. The impoundment, incorporating greater than 800,000 gallons of storage, was sized to store the leachate generated from the landfill cells for greater than 120 days. Peak daily leachate generation values derived from HELP modeling were used in the design of the impoundment. The impoundment is approximately seven feet deep to provide storage of the leachate while maintaining a 3-ft freeboard. The liquid in the leachate impoundment is pumped into tanker vehicles and distributed over the lined waste disposal areas for suppression of dust. The facility maintains a contract with an underground injection company as a secondary means of leachate disposal that can be utilized if needed.

3.5 Ash Filling Operation

The ash filling operation must be performed in a manner to provide run-off control within the disposal cells such that the contact surface water reaches the leachate collection system. This involves grading the placed ash in a controlled manner to direct contact surface water flow toward the leachate collection system in the interior portions of the disposal area. For the Northeastern Plant, stormwater that has had surface contact with the top of waste surface or temporary rain blanket may be directed to the lined Basin C and processed along with non-contact stormwater through the facility OPDES permitted discharge. Once wastes reaches the top of the outboard perimeter berm slopes, the surface water that has contacted the top of waste surface may be released to Basin C. In situations where the outboard slope is ready for closure, surface water that has contacted the top of waste surface will be released over the perimeter berm, into the lined stormwater ditches that flow to Basin C. Once final cover has been placed over all fill areas, stormwater may be released without treatment through Basin C or the facility OPDES permitted discharge.

4.0 - Plan Review and Changes in Facility Configuration

The landfill Owner and/or Operator will review and evaluate this Plan every five (5) years from initial plan preparation and when there are changes in the facility design, construction, operation, or maintenance that materially affect the facility's potential for run-on and run-off control: Amendments to the Plan made to address changes of this nature are referred to as technical or

major amendments, and must be certified by a licensed P.E. Non-technical amendments can be performed by the facility owner and/or operator.

Technical and administrative amendments to the Plan will be documented on the Plan Review Log. The Owner/Operator will make the necessary revisions to the Plan as soon as possible, but no later than six months after the change occurs. The Plan must be implemented as soon as possible following a technical amendment, but no later than six months from the date of the amendment. The AEP Designated Person is responsible for initiating and coordinating revisions to the Run-on and Run-off Control System Plan.

Scheduled reviews and Plan amendments will be recorded in the Plan Review Log provided in **APPENDIX 3**. The log will be completed even if no amendment is made to the Plan as a result of the review.

5.0 - Professional Engineer Certification

The original plan and all reviews and amended plans must obtain certification from a qualified professional engineer stating that the initial and periodic run-on and run-off control system plans meet the requirements of OAC 252:517-13-2. This certification in no way relieves the owner or operator of the facility of his/her duty to fully implement this Plan. The Professional Engineer Certification page is provided in **APPENDIX 4**.

APPENDIX 1: FIGURES

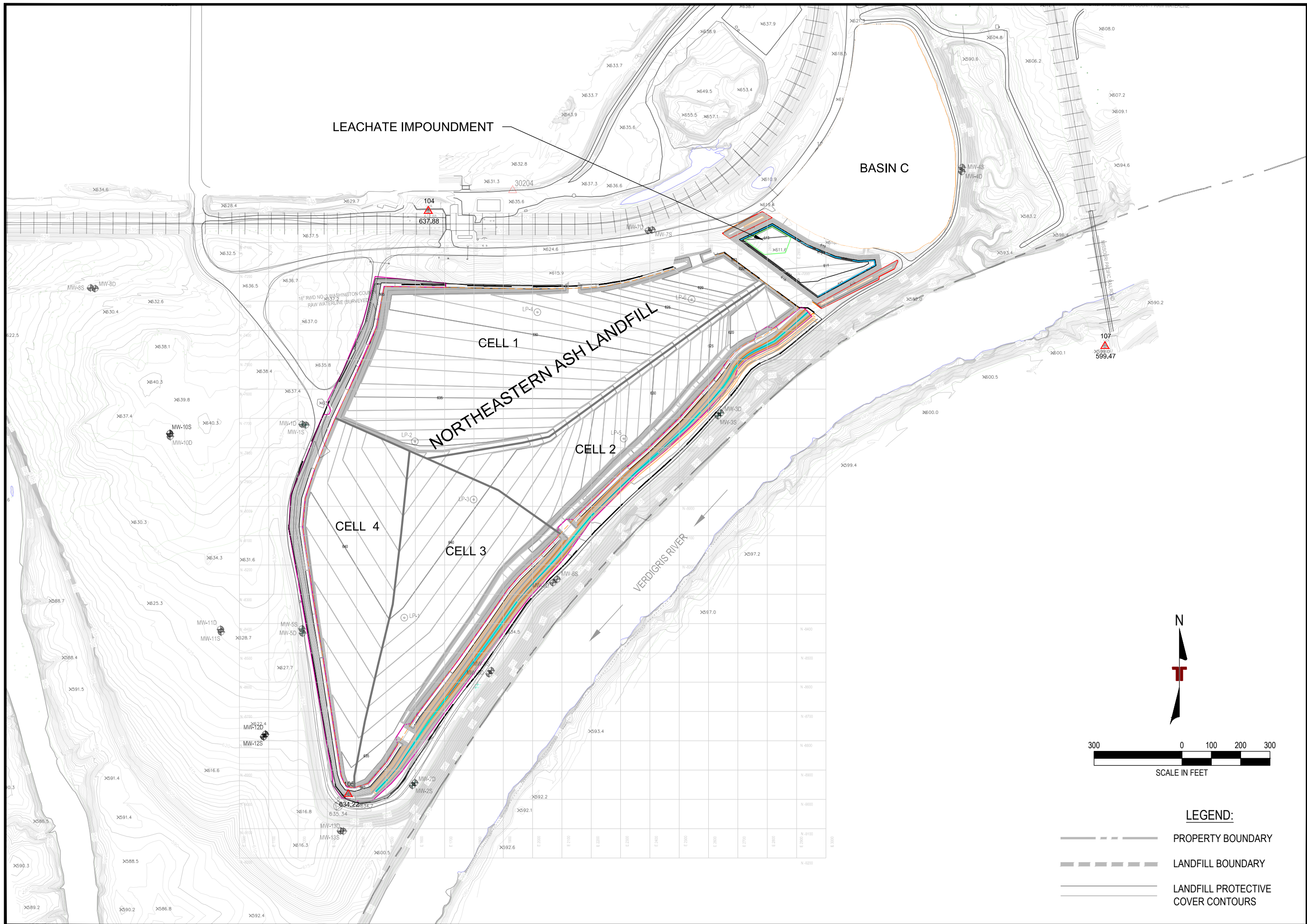

FIGURE 1

DESIGNED BY:	FOC
DRAWN BY:	TLB
APP'D BY:	FOC
SCALE:	SEE BARSCALE
DATE:	9/9/2021
JOB NO.:	216-003-35217182
ACAD NO.:	001
SHEET NO.:	1 OF 5

SITE LAYOUT MAP

RUN-ON AND RUN-OFF CONTROL SYSTEM PLAN

PUBLIC SERVICE COMPANY OF OKLAHOMA

AEP NORTHEASTERN PLANT

OLOGAH OKLAHOMA

Terracon
 Consulting Engineers and Scientists

25609 I-30 SOUTH
 PH. (501) 847-9292

BRYANT, AR 72022
 FAX. (501) 847-9210

REV.	DATE	BY	DESCRIPTION

LEGEND:

- PROPERTY BOUNDARY
- LANDFILL BOUNDARY
- LANDFILL PROTECTIVE COVER CONTOURS

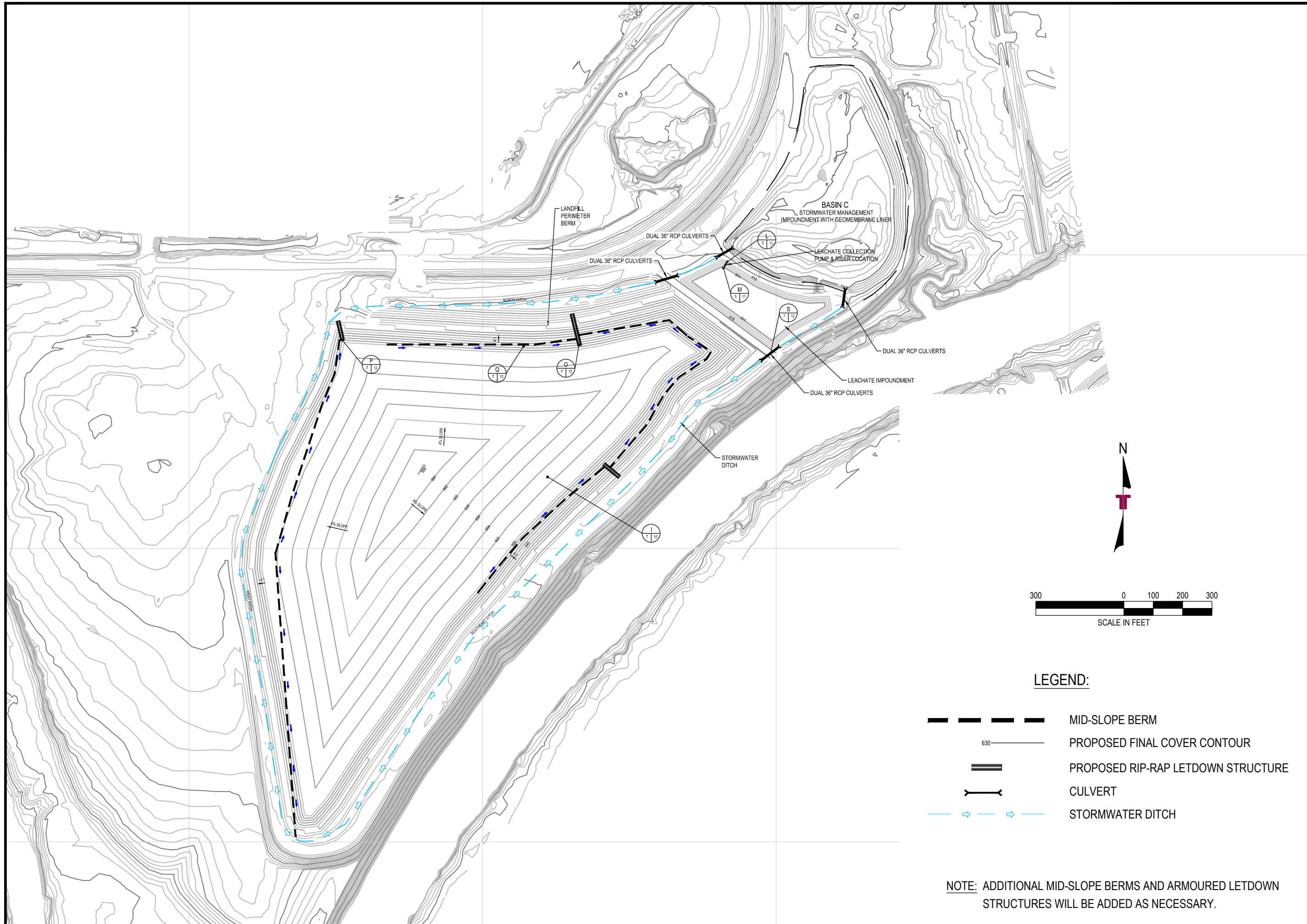

FIGURE 2

DESIGNED BY:	TLB
DRAWN BY:	TLB
APP'D BY:	FOC
SCALE:	SEE BARSCALE
DATE:	9/10/2021
JOB NO.	216-003-36217182
ACAD NO.	002
SHEET NO.:	2 OF 5



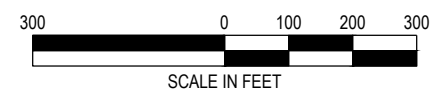

STORMWATER MANAGEMENT PLAN
 RUN-ON AND RUN-OFF CONTROL SYSTEM PLAN
 PUBLIC SERVICE COMPANY OF OKLAHOMA
 AEP NORTHEASTERN PLANT
 OKLAHOMA
 OOLOGAH

Terracon
 Consulting Engineers and Scientists
 25809 I-30 SOUTH
 BRYANT, AR 72022
 PH. (501) 847-9292
 FAX. (501) 847-9270

REV.	DATE	BY	DESCRIPTION



LEGEND:

-  MID-SLOPE BERM
-  PROPOSED FINAL COVER CONTOUR
-  PROPOSED RIP-RAP LETDOWN STRUCTURE
-  CULVERT
-  STORMWATER DITCH

NOTE: ADDITIONAL MID-SLOPE BERMS AND ARMOURED LETDOWN STRUCTURES WILL BE ADDED AS NECESSARY.

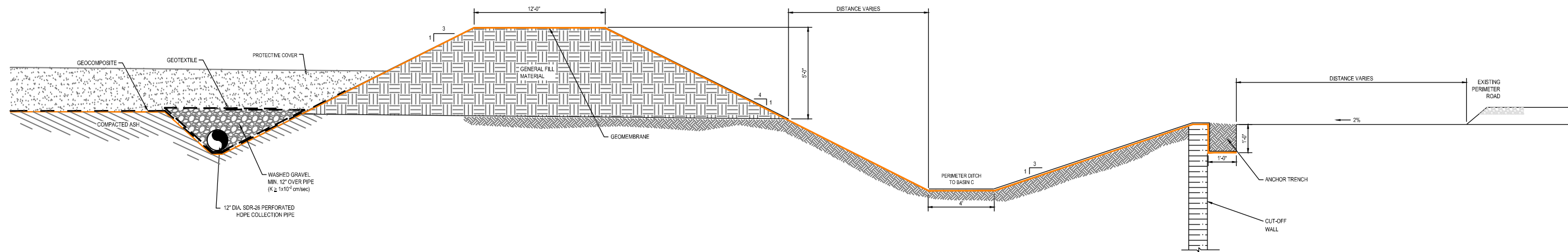

PERIMETER BERM AT CELL 3

SECTION G
SCALE: N.T.S.

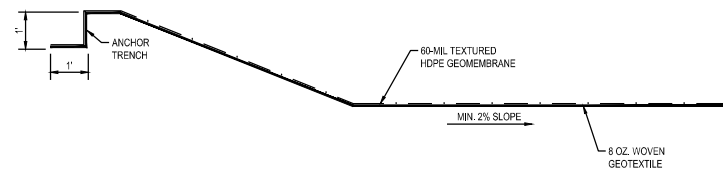

BASIN C LINER DETAIL

SECTION J
SCALE: N.T.S.

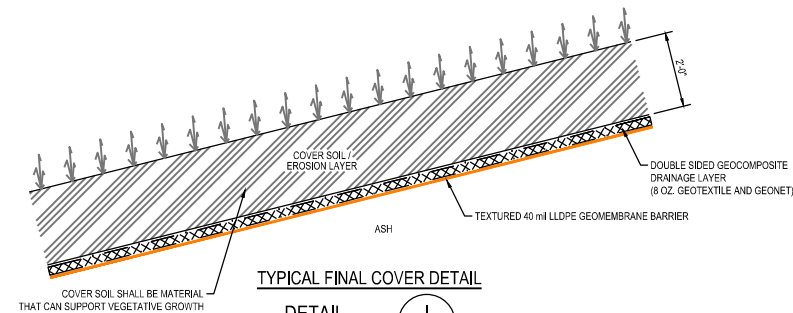

TYPICAL FINAL COVER DETAIL

DETAIL I
SCALE: N.T.S.

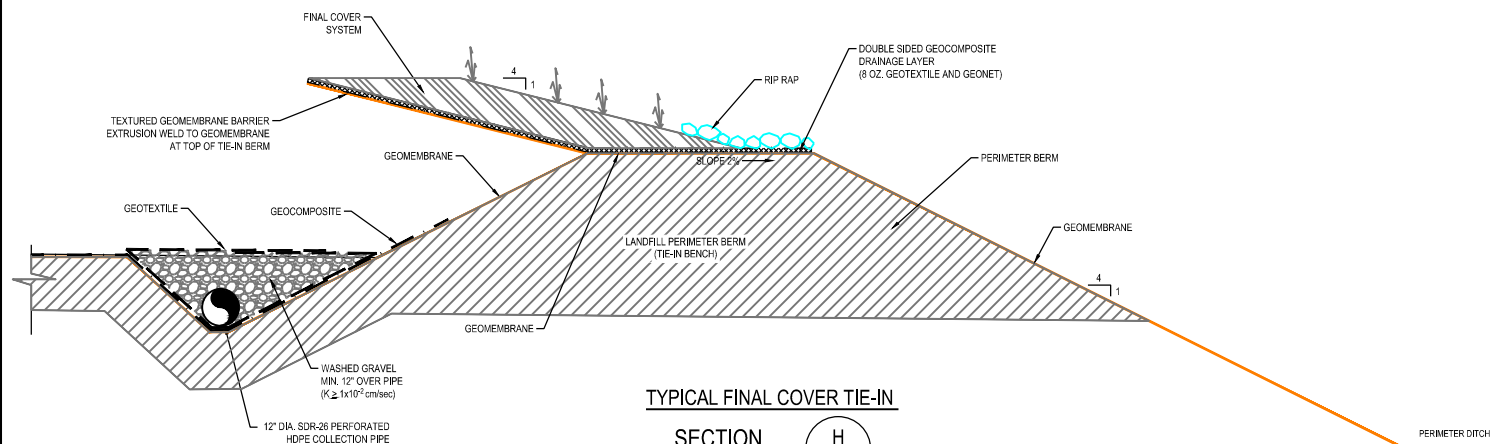

TYPICAL FINAL COVER TIE-IN

SECTION H
SCALE: N.T.S.

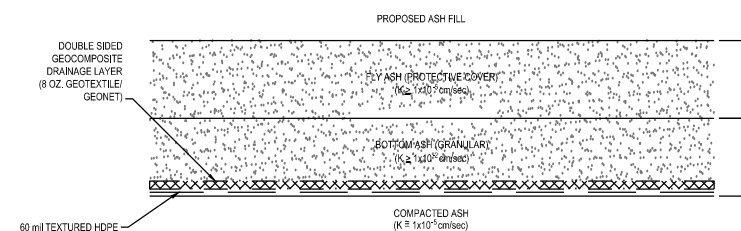

BOTTOM LINER DETAIL

DETAIL K
SCALE: N.T.S.

FIGURE 3

DESIGNED BY:	TLB
DRAWN BY:	TLB
APPVD. BY:	FOC
SCALE:	N.T.S.
DATE:	9/10/2021
JOB NO.:	216-003-36217182
ACAD NO.:	003
SHEET NO.:	3 OF 5

MISCELLANEOUS DETAILS

RUN-ON AND RUN-OFF CONTROL SYSTEM PLAN

PUBLIC SERVICE COMPANY OF OKLAHOMA

AEP NORTHEASTERN PLANT

OKLOGAH

Terracon
Consulting Engineers and Scientists

BRYANT, AR 72022
PH. (501) 847-9292
FAX. (501) 847-9210

REV.	DATE	BY	DESCRIPTION

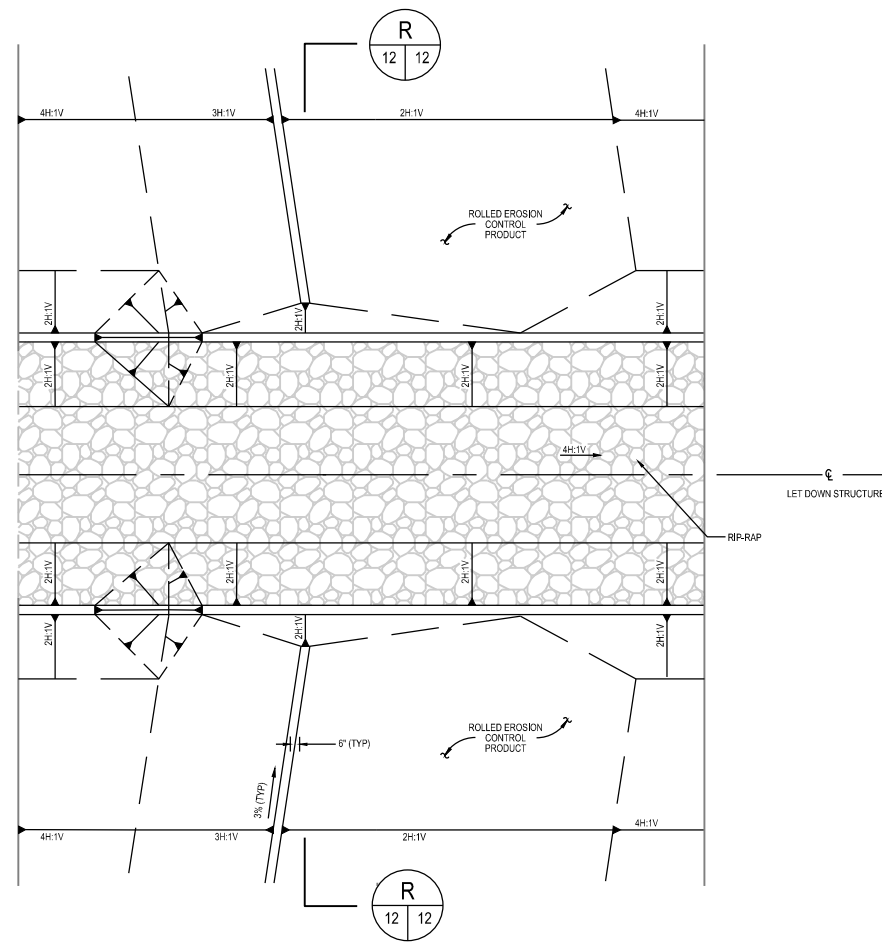

OPTIONAL LETDOWN STRUCTURE DETAIL - DOUBLE BERM INLET

DETAIL
SCALE: N.T.S. O
7 11

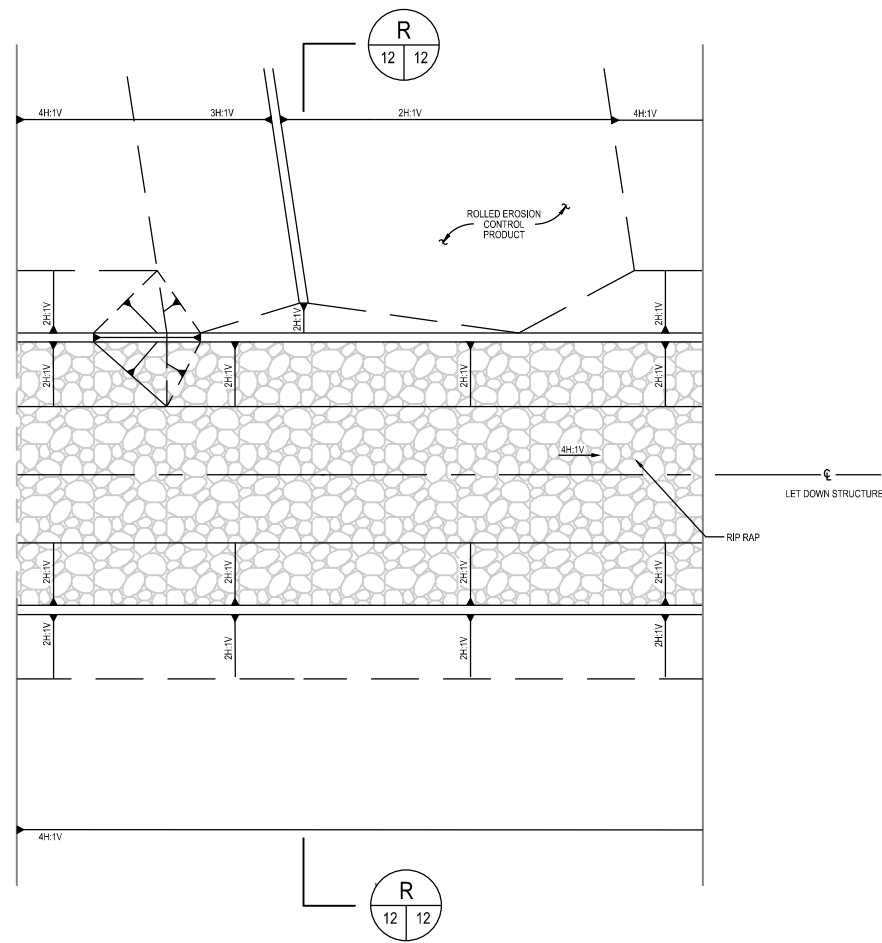

OPTIONAL LETDOWN STRUCTURE DETAIL - SINGLE BERM INLET

DETAIL
SCALE: N.T.S. P
7 11

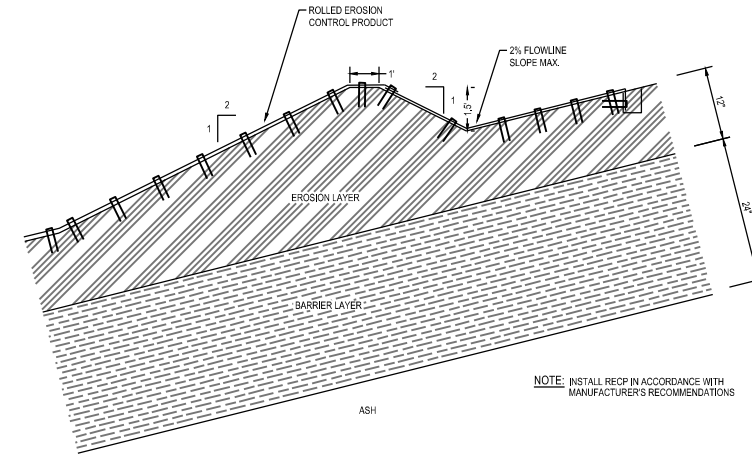

STORMWATER MID-SLOPE BERM W/ ROLLED EROSION CONTROL PRODUCT

DETAIL Q
7 12
SCALE: N.T.S.

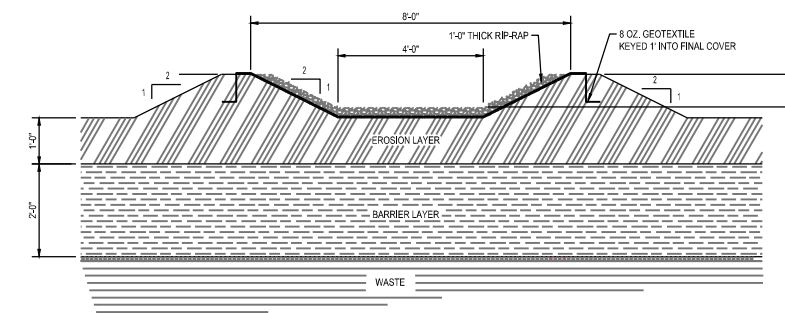

TYPICAL RIP-RAP STORMWATER LETDOWN STRUCTURE

DETAIL R
12 12
SCALE: N.T.S.

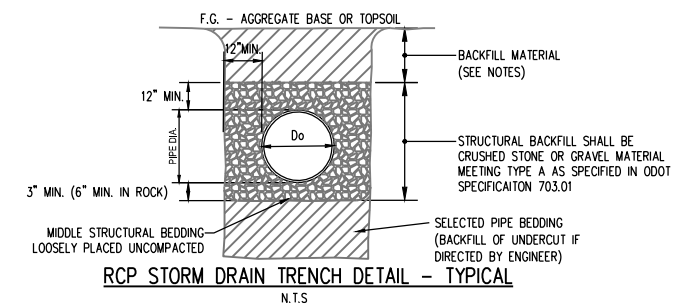

RCP STORM DRAIN TRENCH DETAIL - TYPICAL

TYPICAL PIPE TRENCH DETAIL

DETAIL S
7 12
SCALE: N.T.S.

FIGURE 4

DESIGNED BY:	TLB
DRAWN BY:	TLB
APP'D BY:	FOC
SCALE:	N.T.S.
DATE:	9/10/2021
JOB NO.:	216-003-36217182
ACAD NO.:	004
SHEET NO.:	4 OF 5

STORMWATER MANAGEMENT DETAILS

RUN-ON AND RUN-OFF CONTROL SYSTEM PLAN

PUBLIC SERVICE COMPANY OF OKLAHOMA

AEP NORTHEASTERN PLANT

OKLAHOMA

OOLOGAH

Terracon

Consulting Engineers and Scientists

25809 I-30 SOUTH
PH. (601) 847-9292

BRYANT, AR 72022
FAX. (501) 847-9270

REV	DATE	BY	DESCRIPTION

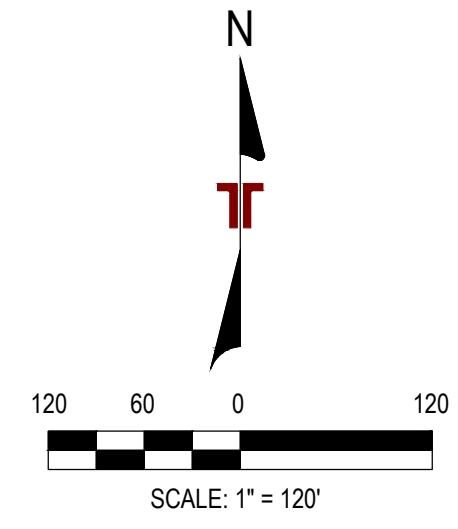
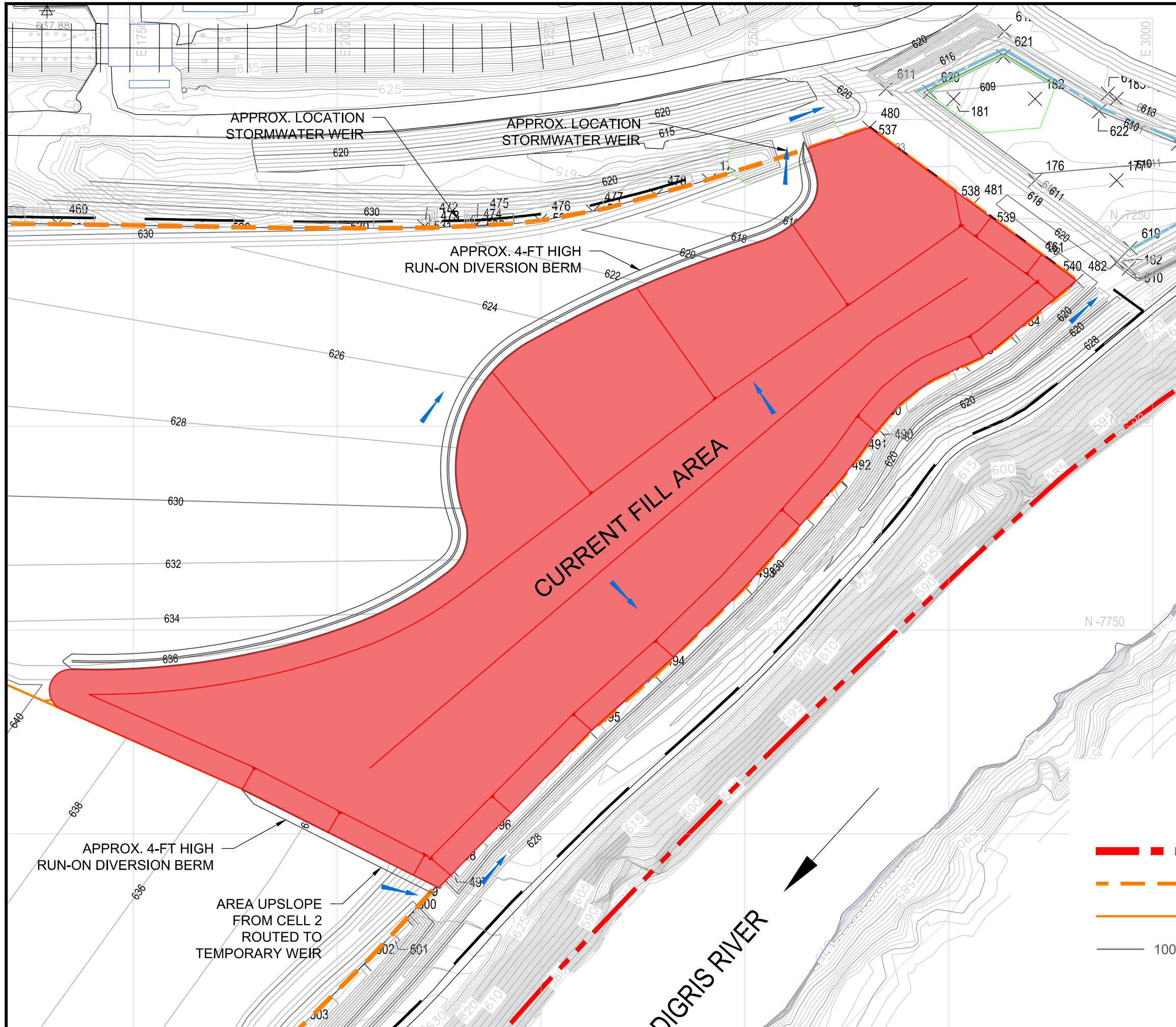

LEGEND

- - - - - PROPERTY BOUNDARY
- - - - - LANDFILL BOUNDARY
- CELL BOUNDARY
- 100 EXISTING CONTOURS (IDX.)

FIGURE 5

DESIGNED BY:	FOC
DRAWN BY:	FOC
APPROVED BY:	
SCALE:	SEE BARS/SCALE
DATE:	9/10/2021
JOB NO.:	216-003-36217182
ACAD NO.:	010
SHEET NO.:	5 OF 5

CURRENT FILL AREA

RUN-ON AND RUN-OFF CONTROL SYSTEM PLAN
PUBLIC SERVICE COMPANY OF OKLAHOMA
AEP NORTHEASTERN PLANT

OOLOGAH
OKLAHOMA

Terracon
Consulting Engineers and Scientists

25809 I-30 SOUTH
PH. (501) 847-9292

BRYANT, AR 72022
FAX. (501) 847-9210

REV.	DATE	BY	DESCRIPTION

APPENDIX 2: STORMWATER CALCULATIONS FROM FACILITY PERMIT MODIFICATION APPLICATION

Stormwater Calculations

Public Service Company of Oklahoma
OSHD Permit No. FA3566010

September 2011
Project No. 35107130



**PUBLIC SERVICE
COMPANY OF
OKLAHOMA**SM

A unit of American Electric Power

PREPARED FOR:

American Electric Power
1 Riverside Plaza
Columbus, OK 43215

PREPARED BY:

Terracon Consultants, Inc.
25809 Interstate 30 South
Bryant, Arkansas 72022
(501) 847-9292

Offices Nationwide
Employee-Owned

Established in 1965
terracon.com

Terracon

Geotechnical ■ Environmental ■ Construction Materials ■ Facilities

TABLE OF CONTENTS

SECTION

CALCULATIONS
MODEL
ANALYSIS
PARAMETERS USED
SUMMARY OF RESULTS
REGULATORY REQUIREMENTS
PERMIT DRAWINGS

ATTACHMENTS

ATTACHMENT A	Mid-Slope Berms and Letdown Structures
ATTACHMENT B	Perimeter Ditches, Culverts and Basin C
ATTACHMENT C	Stormwater Quantities
ATTACHMENT D	OPDES Permit No. OK0034380

PROJECT: Public Service Company of Oklahoma– Stormwater CalculationsPage 1 of 7**JOB NO.:** 35107130**Date:** September 2011**Comp. By:** HAL**CHECKED BY:** FOC**CALCULATIONS BY:**

Heath Lockley, E.I. – Project Engineer
F. Owen Carpenter, P.E. – Senior Project Manager
Terracon Consultants, Inc.
25809 Interstate 30 South
Bryant, Arkansas 72022
(501) 847-9292

MODELS : **TR-55**, (USDA) Urban Hydrology for Small Watersheds, Version 1.00.08
Flowmaster, (Haestad Methods, Inc.), Version 5.10
Microsoft Excel, (Microsoft Corporation), 2002 Edition
HELP, (EPA) Hydraulic Evaluation of Landfill Performance, Version 3.07

ANALYSIS:

Detailed engineering analysis was performed on the components that comprise the stormwater system. The components analyzed for this permit modification include:

1. Mid-Slope Berms
2. Letdown Structures
3. Perimeter Ditches
4. Culverts
5. Existing Pond

The hydrologic analysis was performed utilizing a 25-year, 24-hour rainfall event. The program TR-55 (USDA) Urban Hydrology for Small Watersheds, Version 3.07 was utilized in performing the hydrologic analysis. The analysis was performed for the predevelopment and post development conditions at the Facility. A conservative approach was taken while completing the analysis for each scenario.

The Flowmaster Software (Haestad Methods) was utilized to calculate the capacity of the letdown structures, perimeter ditches and pipes. These results were evaluated using TR-55 output to make sure that the structures had adequate capacity.

Microsoft Excel was utilized to approximate the minimum size of the sedimentation pond for the corresponding proposed watershed modification.

HELP was used to determine stormwater quantities for the landfill. Runoff, evapotranspiration and infiltration were calculated for a typical year. Runoff numbers were used to complete the Stormwater and Leachate Quantity Calculations table. The table was completed using 2 different scenarios involving in-place waste.

PARAMETERS USED IN THE ANALYSES:

The following are the lists of parameters that were considered for the stormwater management:

TR-55

Based on **OAC 252:515-17-2**, a 25-year, 24-hour rainfall event was considered for the proposed modification area. The proposed modification area was first segregated into watersheds, and the areas were approximated. The following **FIGURE 1**, from the TR-55 manual, depicts the approximate geographic boundaries for the NRCS (SCS) rainfall distributions.

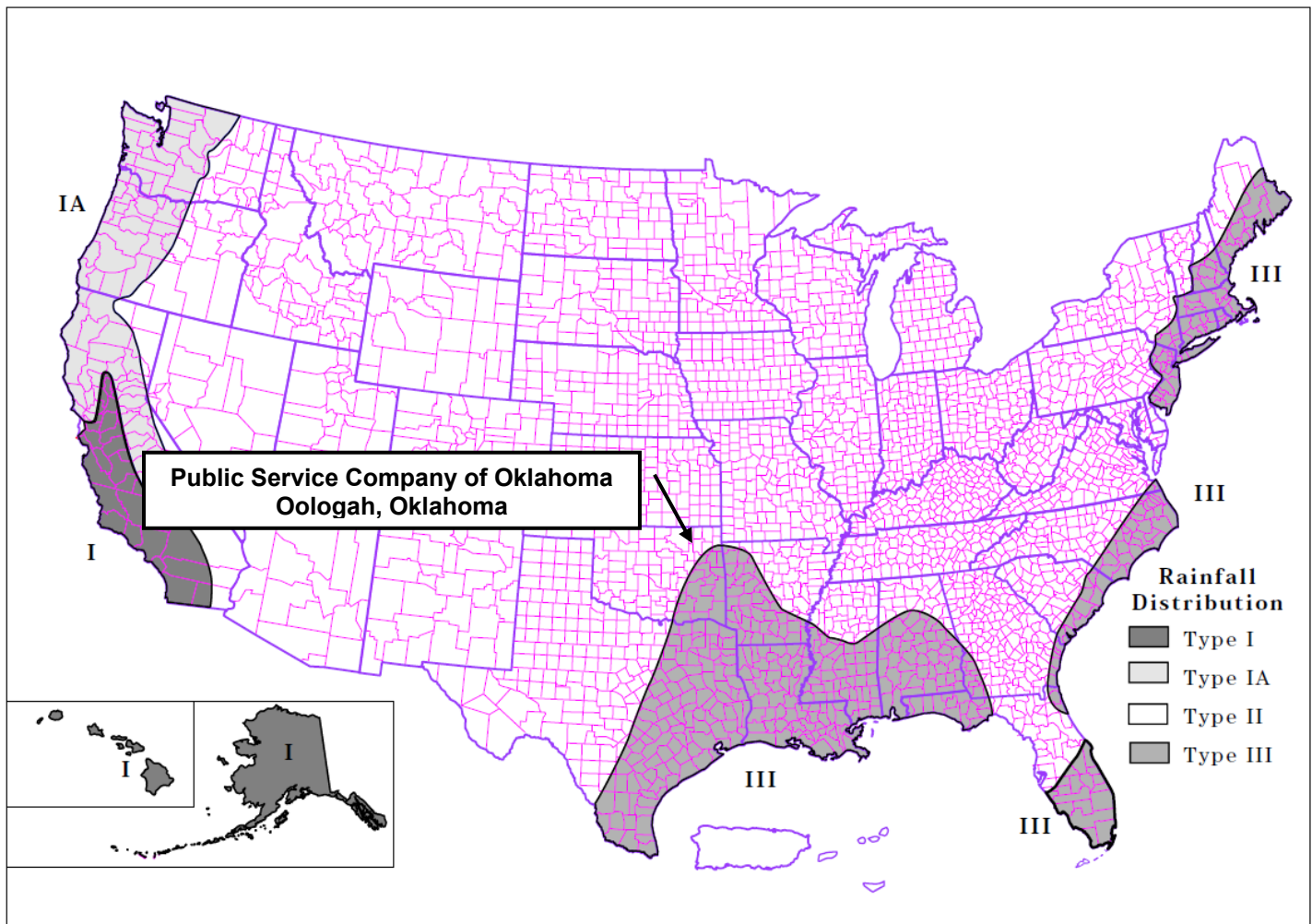

FIGURE 1
APPROXIMATE RAINFALL DISTRIBUTIONS

From the above figure, it was determined that the Landfill would fall into the Type II rainfall distribution as published by the National Weather Service. The following **FIGURE 2**, is a depiction of a 25-year, 24-hour rainfall.

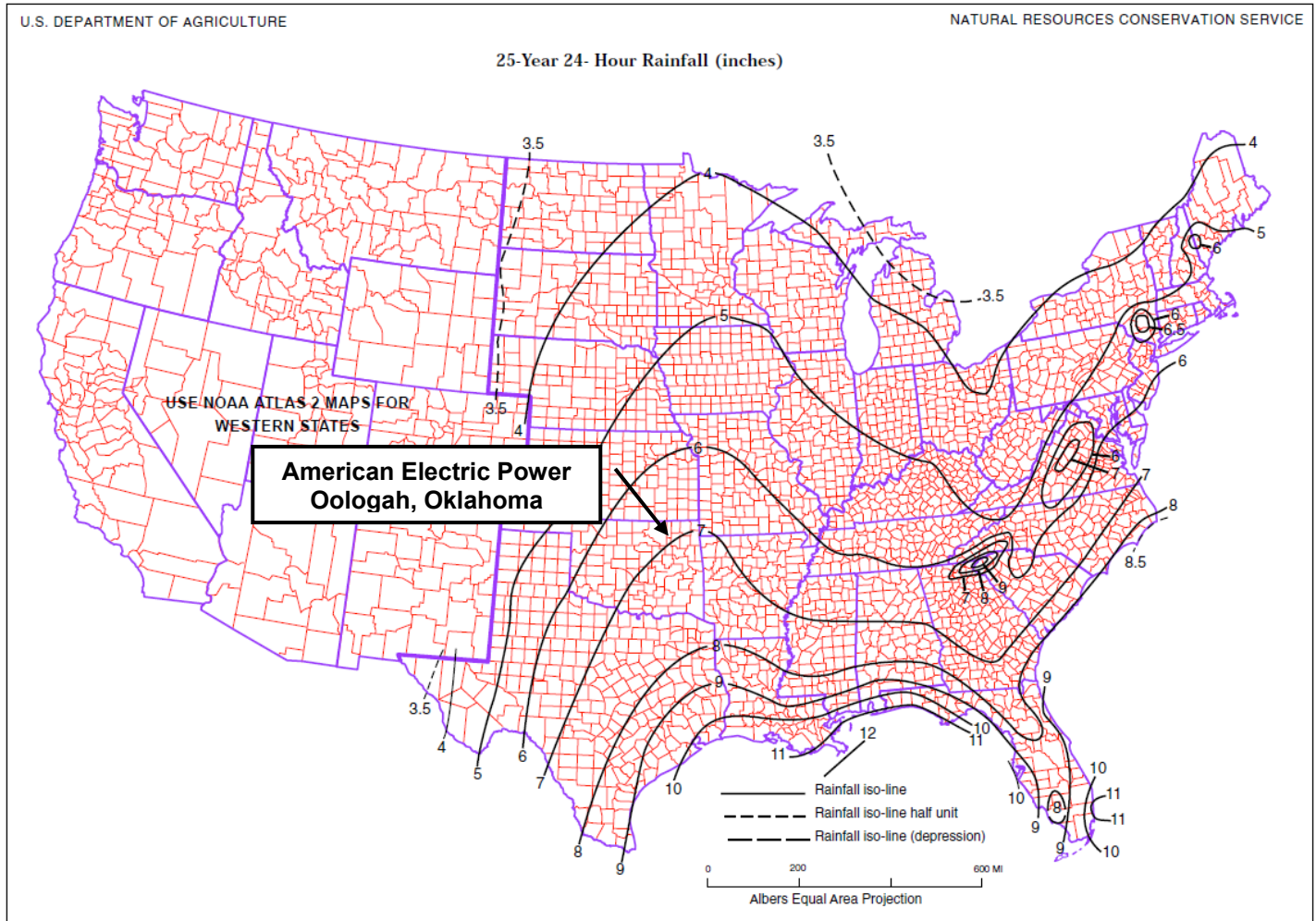

FIGURE 2
25 Year, 24 Hour Rain

From the above figure it was estimated that for analysis that a 7.1 inch rainfall would be used for the generation of the hydrograph.

A conservative approach was used for the determination of the hydrologic soil group for the final cover of the landfill. The conditions at the site were modeled by using the hydrologic soil group C and choosing newly graded area and continuous grass for the land use. The weighted curve number was approximately 74. Newly graded areas were used to design the ditches to carry the flow from the landfill during construction and while filling the landfill. Lower curve numbers were used to design final cover drainage systems with grass maintained areas. Smooth surface conditions were used to provide a larger peak flow and safety factor. The peak flows computed by TR-55 were inserted into the Flowmaster program to complete the design of the structures.

PROJECT: Public Service Company of Oklahoma– Stormwater CalculationsPage 4 of 7JOB NO.: 35107130Date: September 2011Comp. By: HALCHECKED BY: FOC

FLOWMASTER

The parameters for Flowmaster, Haestad Methods model included using Manning's equation and Manning's coefficient for the appropriate surface. The following is the Manning's equation that was used to estimate the capacity of the proposed mid-slope berms, perimeter ditches and pipes.

$$Q = \frac{1.49}{n} AR^{2/3} S^{1/2}$$

Where:

Q = flow of the fluid

n = Manning's coefficient

A = cross sectional area of the fluid

R = Hydraulic Radius

S = the head loss per unit length of channel, approximated by the channel slope

Once the flow capacity was determined from the Manning's Equation it was compared to the peak discharge for the area from the TR-55 output to confirm that it was more than adequate to sustain the predicted flow.

MICROSOFT EXCEL

Microsoft Excel was used to input calculations to determine if the existing pond would be able to hold a 25 year, 24 hour storm. A conservative method was used to estimate the capabilities of the pond. Evaporation and infiltration were not accounted for, providing a needed capacity assuming 100 percent runoff.

HELP MODEL

HELP was used to provide evapotranspiration, infiltration and runoff values for the worst case scenario of the proposed modification. The values were used to approximate the quantity of leachate and stormwater that would accumulate over a year.

PROJECT: Public Service Company of Oklahoma– Stormwater Calculations

Page 5 of 7

JOB NO.: 35107130

Date: September 2011

Comp. By: HAL

CHECKED BY: FOC

SUMMARY OF RESULTS:

The following sections summarize the results from the stormwater calculations. Calculation printouts can be seen in the attachments as follows:

ATTACHMENT A	Mid-Slope Berms and Letdown Structures
ATTACHMENT B	Perimeter Ditches and Culverts
ATTACHMENT C	Stormwater Quantities
ATTACHMENT D	OPDES Permit No. OK0034380

MID-SLOPE BERMS

The mid-slope stormwater berms were designed to convey stormwater from a maximum acreage of 3.5 to the letdown structures. The maximum area that has been designed to be directed into a letdown structure is roughly 7.2 acres. The side slopes of the berms will be 2H:1V and have a one foot top width. The berms will be a minimum height of 1.5 feet and allow for a minimum 3" freeboard. The mid-slope berms will need to have the flow capacity of approximately 21.5 cfs. A maximum of approximately 23 cfs will be able to flow down the mid-slope berms at an estimated 2 percent slope.

LETDOWN STRUCTURES

The rip-rap letdown structures will direct the water from the mid-slope berms to the perimeter ditches. The proposed design will route the flow from a maximum of 7.2 acres to any one letdown structure having a maximum flow of near 50 cfs. The letdown structures are designed to carry approximately 89 cfs on a 25 percent slope, providing a safety factor. The letdown structures will be a minimum of 8 feet wide at the top and have a 4 foot flat bottom. The side slopes will be approximately at a 2H:1V slope. The letdown structures will be a minimum of one foot deep.

PERIMETER DITCHES

Peak discharges for the areas needing perimeter ditches were calculated by TR-55 for a 25-year, 24-hour rainfall event. Peak flow for the north ditch is approximately 93 cfs. The capacity of the north ditch is a minimum of approximately 185 cfs. The west ditch will carry minimal stormwater to the southeast ditch. TR-55 determined that the west and southeast ditch would have a flow of approximately 168 cfs. The southeast ditch will convey roughly 185 cfs. The typical trapezoidal ditch section will have a 4 foot flat bottom with 2:1 side slopes.

PROJECT: Public Service Company of Oklahoma– Stormwater Calculations

Page 6 of 7

JOB NO.: 35107130

Date: September 2011

Comp. By: HAL

CHECKED BY: FOC

CULVERTS

There will be 2 sets of reinforced concrete pipes (RCP) directing stormwater flow into the existing pond. The pipes will direct water from the perimeter ditches to the existing stormwater collection basin (Basin C). Haestad Methods was used to calculate the required pipe size. The perimeter ditches have maximum flow of approximately 170 cfs. In both cases two 36 inch pipes at 2.8% slope (min. required slope = 1.6%) will be used to convey the stormwater to Basin C. Two 36" RCP pipes will carry a maximum flow of roughly 223 cfs at 2.8% slope.

BASIN C

The existing stormwater flow conditions were analyzed using TR-55. TR-55 calculated the existing flow around the landfill from a 25 year, 24 hour storm. The runoff was routed to Basin C in the northeast corner of the landfill. The capacity of Basin C was determined to be approximately 12,768,921 gallons at a constant elevation of 616 feet. The accumulated rainfall from a 25 year, 24 hour storm was roughly 8,272,686 gallons. A 25 year, 24 hour storm can be held in the stormwater pond if the elevation before the storm is approximately 611 feet. The perimeter berm surrounding the Landfill and the stormwater pond will be at an approximate elevation of 620 feet providing four feet of freeboard after the storm. OAC 252:515-17-2(2) requires that a run-off control system be in place that can collect and control stormwater resulting from a 25 year, 24 hour storm. The existing stormwater pond has enough capacity to contain a storm of that magnitude without pumping. Stormwater approximate annual totals can be seen in **ATTACHMENT C**. The totals were calculated using the HELP and TR-55 Models provided in this Permit Modification Application.

REGULATORY REQUIREMENTS:

RUN-ON CONTROL SYSTEM

OAC 252:515-17-2(1) states that a run-on control system must be in place to prevent flow onto active portions of the facility during peak discharge from a 24-hour, 25 year storm.

The active portions of the site will be contained by the perimeter berms which function as roads around the active area. The runoff from the perimeter roads will be treated as stormwater from the active areas and is considered insignificant. Run-on flow will not be directed onto the landfill. If minimal run-on does occur due to unusual rainfall events, the run-on will be routed around the landfill in the perimeter ditches and treated with stormwater from the active areas.

PROJECT: Public Service Company of Oklahoma– Stormwater Calculations

Page 7 of 7

JOB NO.: 35107130 Date: September 2011 Comp. By: HAL CHECKED BY: FOC

OPDES PERMIT

AEP has an existing OPDES Permit (Permit No. OK0034380). AEP will comply with all discharges requirements of OAC:515-17-3. The existing OPDES Permit is presented in **ATTACHMENT D**.

PERMIT DRAWINGS:

The Stormwater Management Plan is presented on **Drawing 7** of 12 - Stormwater Management Plan of the Permit Drawings. Details of the stormwater handling features are also shown on **Drawings 12** of 12.

ATTACHMENT A

MID-SLOPE BERMS AND LETDOWN STRUCTURES

Mid Slope Berms
Worksheet for Triangular Channel

Project Description	
Project File	n:\projects\2008\35087115\volume~2\stormw~1\midslo~1.fm2
Worksheet	Mid-Slope Berm
Flow Element	Triangular Channel
Method	Manning's Formula
Solve For	Discharge

Input Data	
Mannings Coefficient	0.030
Channel Slope	0.020000 ft/ft
Depth	1.25 ft
Left Side Slope	2.000000 H : V
Right Side Slope	4.000000 H : V

Results		
Discharge	23.09	cfs
Flow Area	4.69	ft ²
Wetted Perimeter	7.95	ft
Top Width	7.50	ft
Critical Depth	1.30	ft
Critical Slope	0.016369	ft/ft
Velocity	4.93	ft/s
Velocity Head	0.38	ft
Specific Energy	1.63	ft
Froude Number	1.10	
Flow is supercritical.		

Mid Slope Berm Cross Section
Cross Section for Triangular Channel

Project Description	
Project File	n:\projects\2008\35087115\volume~2\stormw~1\midslo~1.fm2
Worksheet	Mid-Slope Berm
Flow Element	Triangular Channel
Method	Manning's Formula
Solve For	Discharge

Section Data	
Mannings Coefficient	0.030
Channel Slope	0.020000 ft/ft
Depth	1.25 ft
Left Side Slope	2.000000 H : V
Right Side Slope	4.000000 H : V
Discharge	23.09 cfs

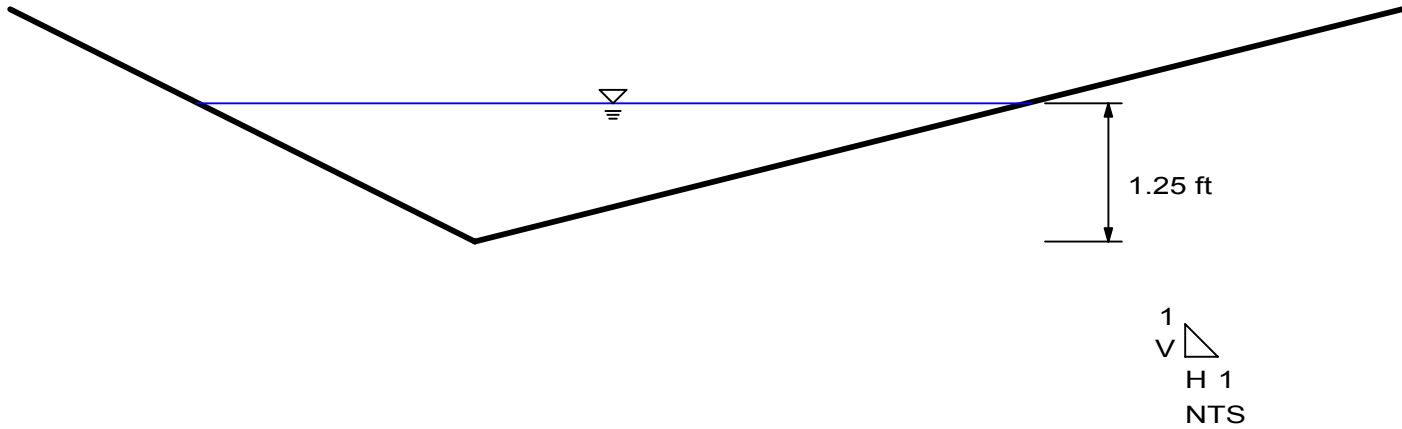

Letdown Structures
Worksheet for Trapezoidal Channel

Project Description	
Project File	n:\projects\2008\35087115\volume 3 - design information\stormwater management plan\letdown.fm2
Worksheet	Letdown Structures
Flow Element	Trapezoidal Channel
Method	Manning's Formula
Solve For	Channel Slope

Input Data		
Mannings Coefficient	0.040	
Depth	1.00	ft
Left Side Slope	2.000000	H : V
Right Side Slope	2.000000	H : V
Bottom Width	4.00	ft
Discharge	88.54	cfs

Results		
Channel Slope	0.250000	ft/ft
Flow Area	6.00	ft ²
Wetted Perimeter	8.47	ft
Top Width	8.00	ft
Critical Depth	1.83	ft
Critical Slope	0.023947	ft/ft
Velocity	14.76	ft/s
Velocity Head	3.38	ft
Specific Energy	4.38	ft
Froude Number	3.00	
Flow is supercritical.		

Letdown Cross Section
Cross Section for Trapezoidal Channel

Project Description	
Project File	n:\projects\2008\35087115\volume 3 - design information\stormwater management plan\letdown.fm2
Worksheet	Letdown Structures
Flow Element	Trapezoidal Channel
Method	Manning's Formula
Solve For	Channel Slope

Section Data	
Mannings Coefficient	0.040
Channel Slope	0.250000 ft/ft
Depth	1.00 ft
Left Side Slope	2.000000 H : V
Right Side Slope	2.000000 H : V
Bottom Width	4.00 ft
Discharge	88.54 cfs

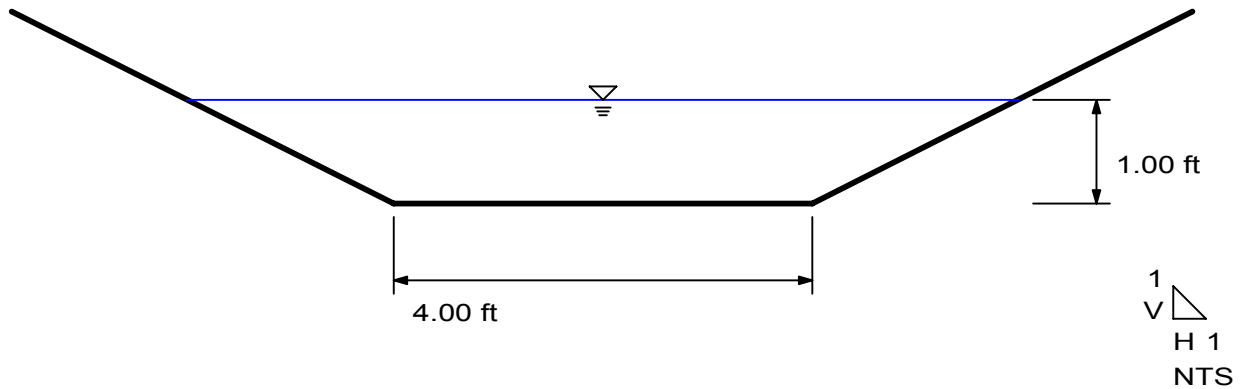

WinTR-55 Current Data Description

--- Identification Data ---

User: H. Lockley Date: 10/4/2011
 Project: 35107130 Units: English
 SubTitle: Mid Slope Berm & Letdown Stormwater Areal Units: Acres
 State: Oklahoma
 County: Rogers
 Filename: N:\Projects\2010\35107130\Permit Application\100% Revision\Volume 3 - Design Information\App.D S

--- Sub-Area Data ---

Name	Description	Reach	Area(ac)	RCN	Tc
N MS 1	MS West of Letdown	Outlet	3.25	74	.145
N MS 2	MS East of Letdown	Outlet	3.25	74	.126
SE MS 1	MS West of Letdown	Outlet	3.5	74	.145
SE MS 2	MS East of Letdown	Outlet	3.5	74	.126

Total area: 13.50 (ac)

--- Storm Data ---

Rainfall Depth by Rainfall Return Period

2-Yr (in)	5-Yr (in)	10-Yr (in)	25-Yr (in)	50-Yr (in)	100-Yr (in)	1-Yr (in)
4.0	5.1	6.1	7.1	7.9	8.8	3.2

Storm Data Source: Rogers County, OK (NRCS)
 Rainfall Distribution Type: Type II
 Dimensionless Unit Hydrograph: <standard>

H. Lockley

35107130
Mid Slope Berm & Letdown Stormwater
Rogers County, Oklahoma

Storm Data

Rainfall Depth by Rainfall Return Period

2-Yr (in)	5-Yr (in)	10-Yr (in)	25-Yr (in)	50-Yr (in)	100-Yr (in)	1-Yr (in)
4.0	5.1	6.1	7.1	7.9	8.8	3.2

Storm Data Source: Rogers County, OK (NRCS)
Rainfall Distribution Type: Type II
Dimensionless Unit Hydrograph: <standard>

H. Lockley

35107130
Mid Slope Berm & Letdown Stormwater
Rogers County, Oklahoma

Watershed Peak Table

Sub-Area or Reach Identifier	Peak Flow by Rainfall Return Period 25-Yr (cfs)

SUBAREAS	
N MS 1	19.14
N MS 2	19.74
SE MS 1	20.61
SE MS 2	21.26
REACHES	
OUTLET	80.54

H. Lockley

35107130
Mid Slope Berm & Letdown Stormwater
Rogers County, Oklahoma

Hydrograph Peak/Peak Time Table

Sub-Area Peak Flow and Peak Time (hr) by Rainfall Return Period
or Reach 25-Yr
Identifier (cfs)
 (hr)

SUBAREAS

N MS 1 19.14
 11.96

N MS 2 19.74
 11.95

SE MS 1 20.61
 11.96

SE MS 2 21.26
 11.95

REACHES

OUTLET 80.54

H. Lockley

35107130
Mid Slope Berm & Letdown Stormwater
Rogers County, Oklahoma

Sub-Area Summary Table

Sub-Area Identifier	Drainage Area (ac)	Time of Concentration (hr)	Curve Number	Receiving Reach	Sub-Area Description
N MS 1	3.25	0.145	74	Outlet	MS West of Letdown
N MS 2	3.25	0.126	74	Outlet	MS East of Letdown
SE MS 1	3.50	0.145	74	Outlet	MS West of Letdown
SE MS 2	3.50	0.126	74	Outlet	MS East of Letdown

Total Area: 13.50 (ac)

H. Lockley

35107130
Mid Slope Berm & Letdown Stormwater
Rogers County, Oklahoma

Sub-Area Time of Concentration Details

Sub-Area Identifier/	Flow Length (ft)	Slope (ft/ft)	Mannings's n	End Area (sq ft)	Wetted Perimeter (ft)	Velocity (ft/sec)	Travel Time (hr)

N MS 1							
SHEET	100	0.0400	0.150				0.111
SHALLOW	400	0.0400	0.050				0.034
					Time of Concentration		.145
							=====
N MS 2							
SHEET	100	0.0400	0.150				0.111
SHALLOW	160	0.0400	0.050				0.014
SHALLOW	40	0.2500	0.050				0.001
					Time of Concentration		.126
							=====
SE MS 1							
SHEET	100	0.0400	0.150				0.111
SHALLOW	400	0.0400	0.050				0.034
					Time of Concentration		.145
							=====
SE MS 2							
SHEET	100	0.0400	0.150				0.111
SHALLOW	160	0.0400	0.050				0.014
SHALLOW	40	0.2500	0.050				0.001
					Time of Concentration		.126
							=====

H. Lockley

35107130
Mid Slope Berm & Letdown Stormwater
Rogers County, Oklahoma

Sub-Area Land Use and Curve Number Details

Sub-Area Identifier	Land Use		Hydrologic Soil Group	Sub-Area Area (ac)	Curve Number
N MS 1	Open space; grass cover > 75%	(good)	C	3.25	74
	Total Area / Weighted Curve Number			3.25	74
				====	==
N MS 2	Open space; grass cover > 75%	(good)	C	3.25	74
	Total Area / Weighted Curve Number			3.25	74
				====	==
SE MS 1	Open space; grass cover > 75%	(good)	C	3.5	74
	Total Area / Weighted Curve Number			3.5	74
				===	==
SE MS 2	Open space; grass cover > 75%	(good)	C	3.5	74
	Total Area / Weighted Curve Number			3.5	74
				===	==

ATTACHMENT B

PERIMETER DITCHES AND CULVERTS

Worksheet
Worksheet for Trapezoidal Channel

Project Description	
Project File	o:\hold\haestad\fmw\oologah.fm2
Worksheet	Landfill Ditches
Flow Element	Trapezoidal Channel
Method	Manning's Formula
Solve For	Discharge

Input Data	
Mannings Coefficient	0.030
Channel Slope	0.007500 ft/ft
Depth	3.00 ft
Left Side Slope	2.000000 H : V
Right Side Slope	2.000000 H : V
Bottom Width	4.00 ft

Results		
Discharge	184.91	cfs
Flow Area	30.00	ft ²
Wetted Perimeter	17.42	ft
Top Width	16.00	ft
Critical Depth	2.67	ft
Critical Slope	0.012263	ft/ft
Velocity	6.16	ft/s
Velocity Head	0.59	ft
Specific Energy	3.59	ft
Froude Number	0.79	
Flow is subcritical.		

Cross Section
Cross Section for Trapezoidal Channel

Project Description	
Project File	o:\hold\haestad\fmw\oologah.fm2
Worksheet	Landfill Ditches
Flow Element	Trapezoidal Channel
Method	Manning's Formula
Solve For	Discharge

Section Data	
Mannings Coefficient	0.030
Channel Slope	0.007500 ft/ft
Depth	3.00 ft
Left Side Slope	2.000000 H : V
Right Side Slope	2.000000 H : V
Bottom Width	4.00 ft
Discharge	184.91 cfs

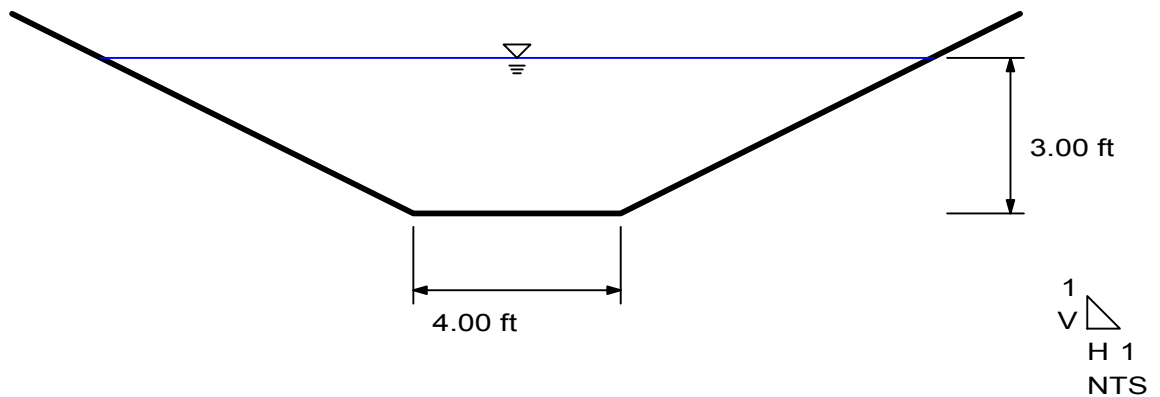

Cross Section
Cross Section for Circular Channel

Project Description	
Project File	o:\hold\haestad\fmw\oologah.fm2
Worksheet	PSO Dual 36" RCP CULVERTS
Flow Element	Circular Channel
Method	Manning's Formula
Solve For	Discharge

Section Data		
Mannings Coefficient	0.013	
Channel Slope	0.028000 ft/ft	
Depth	3.00	ft
Diameter	36.00	in
Discharge	111.60	cfs

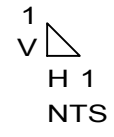
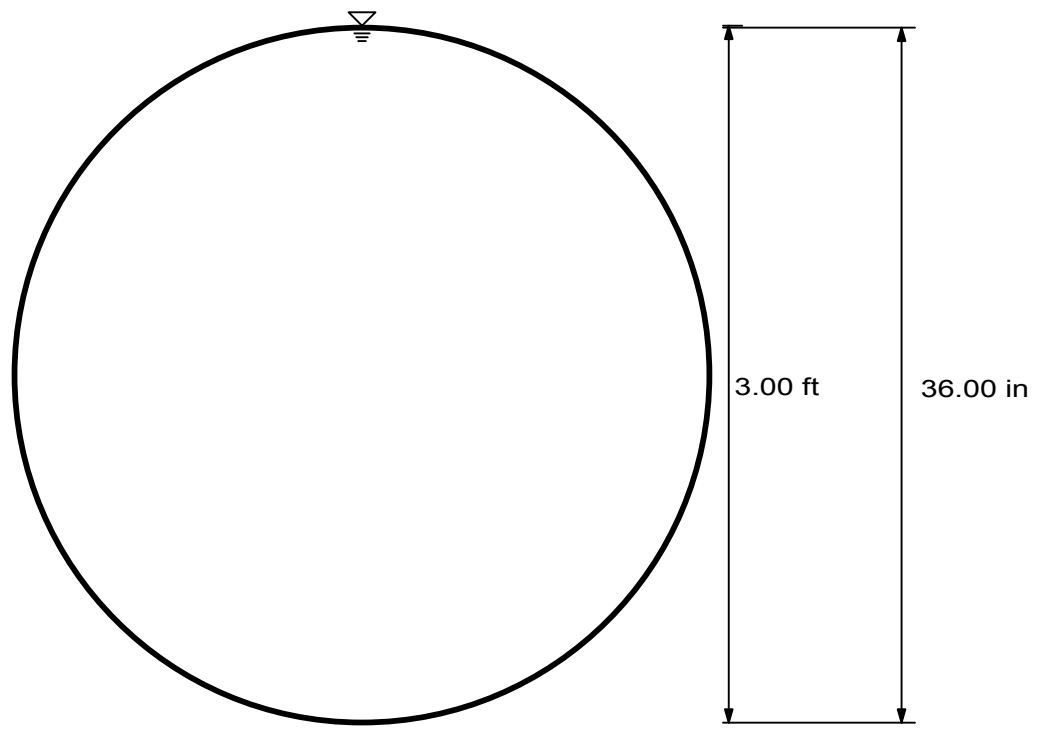

WinTR-55 Current Data Description

--- Identification Data ---

User: H. Lockley Date: 10/4/2011
 Project: 35107130 Units: English
 SubTitle: Final Cover System Stormwater Runoff Areal Units: Acres
 State: Oklahoma
 County: Rogers
 Filename: N:\Projects\2010\35107130\Permit Application\100% Revision\Volume 3 - Design Information\App.D S

--- Sub-Area Data ---

Name	Description	Reach	Area(ac)	RCN	Tc
Area 1	North Side of Landfill	N Ditch	14	79	.147
Area 2	West Side Above MS	SE Ditch	7	79	.14
Area 3	Southeast Side of LF	SE Ditch	16	79	.148
Area 4	West Side Below MS	W Ditch	3	79	0.1

Total area: 40 (ac)

--- Storm Data --

Rainfall Depth by Rainfall Return Period

2-Yr (in)	5-Yr (in)	10-Yr (in)	25-Yr (in)	50-Yr (in)	100-Yr (in)	1-Yr (in)
4.0	5.1	6.1	7.1	7.9	8.8	3.2

Storm Data Source: Rogers County, OK (NRCS)
 Rainfall Distribution Type: Type II
 Dimensionless Unit Hydrograph: <standard>

H. Lockley

35107130
Final Cover System Stormwater Runoff
Rogers County, Oklahoma

Storm Data

Rainfall Depth by Rainfall Return Period

2-Yr (in)	5-Yr (in)	10-Yr (in)	25-Yr (in)	50-Yr (in)	100-Yr (in)	1-Yr (in)
4.0	5.1	6.1	7.1	7.9	8.8	3.2

Storm Data Source: Rogers County, OK (NRCS)
Rainfall Distribution Type: Type II
Dimensionless Unit Hydrograph: <standard>

H. Lockley

35107130
Final Cover System Stormwater Runoff
Rogers County, Oklahoma

Watershed Peak Table

Sub-Area or Reach Identifier	Peak Flow by Rainfall Return Period 25-Yr (cfs)

SUBAREAS	
Area 1	92.21
Area 2	46.62
Area 3	105.23
Area 4	21.40
REACHES	
N Ditch	92.21
Down	89.18
W Ditch	21.40
Down	20.03
SE Ditch	167.21
Down	161.67
OUTLET	249.96

H. Lockley

35107130
Final Cover System Stormwater Runoff
Rogers County, Oklahoma

Hydrograph Peak/Peak Time Table

Sub-Area Peak Flow and Peak Time (hr) by Rainfall Return Period
or Reach 25-Yr
Identifier (cfs)
 (hr)

SUBAREAS

Area 1 92.21
 11.96

Area 2 46.62
 11.95

Area 3 105.23
 11.96

Area 4 21.40
 11.93

REACHES

N Ditch 92.21
 11.96
 Down 89.18
 12.04

W Ditch 21.40
 11.93
 Down 20.03
 12.05

SE Ditch 167.21
 11.97
 Down 161.67
 12.07

OUTLET 249.96

H. Lockley

35107130

Final Cover System Stormwater Runoff
Rogers County, Oklahoma

Structure Output Table

Reach Identifier Peak Flow (PF), Storage Volume (SV), Stage (STG)
Structure Identifier by Rainfall Return Period
25-Yr

H. Lockley

35107130
Final Cover System Stormwater Runoff
Rogers County, Oklahoma

Sub-Area Summary Table

Sub-Area Identifier	Drainage Area (ac)	Time of Concentration (hr)	Curve Number	Receiving Reach	Sub-Area Description
Area 1	14.00	0.147	79	N Ditch	North Side of Landfill
Area 2	7.00	0.140	79	SE Ditch	West Side Above MS
Area 3	16.00	0.148	79	SE Ditch	Southeast Side of LF
Area 4	3.00	0.100	79	W Ditch	West Side Below MS
Total Area:	40 (ac)				

H. Lockley

35107130
Final Cover System Stormwater Runoff
Rogers County, Oklahoma

Reach Summary Table

Reach Identifier	Receiving Reach Identifier	Reach Length (ft)	Routing Method
N Ditch	Outlet	1600	CHANNEL
W Ditch	SE Ditch	1500	CHANNEL
SE Ditch	Outlet	2250	CHANNEL

Sub-Area Time of Concentration Details

Sub-Area Identifier/	Flow Length (ft)	Slope (ft/ft)	Mannings's n	End Area (sq ft)	Wetted Perimeter (ft)	Velocity (ft/sec)	Travel Time (hr)

Area 1							
SHEET	100	0.0400	0.150				0.111
SHALLOW	400	0.0400	0.050				0.034
SHALLOW	50	0.2500	0.050				0.002
					Time of Concentration		.147
							=====
Area 2							
SHEET	100	0.0400	0.150				0.111
SHALLOW	300	0.0400	0.050				0.026
SHALLOW	100	0.2500	0.050				0.003
					Time of Concentration		.14
							=====
Area 3							
SHEET	100	0.0400	0.150				0.111
SHALLOW	400	0.0400	0.050				0.034
SHALLOW	100	0.2500	0.050				0.003
					Time of Concentration		.148
							=====
Area 4							
SHEET	50	0.2500	0.150				0.031
					Time of Concentration		0.1
							=====

H. Lockley

35107130
Final Cover System Stormwater Runoff
Rogers County, Oklahoma

Sub-Area Land Use and Curve Number Details

Sub-Area Identifier	Land Use	Hydrologic Soil Group	Sub-Area Area (ac)	Curve Number
Area 1	Open space; grass cover 50% to 75% (fair)	C	14	79
	Total Area / Weighted Curve Number		14 ==	79 ==
Area 2	Open space; grass cover 50% to 75% (fair)	C	7	79
	Total Area / Weighted Curve Number		7 =	79 ==
Area 3	Open space; grass cover 50% to 75% (fair)	C	16	79
	Total Area / Weighted Curve Number		16 ==	79 ==
Area 4	Open space; grass cover 50% to 75% (fair)	C	3	79
	Total Area / Weighted Curve Number		3 =	79 ==

H. Lockley

35107130
 Final Cover System Stormwater Runoff
 Rogers County, Oklahoma

Reach Channel Rating Details

Reach Identifier	Reach Length (ft)	Reach Manning's n	Friction Slope (ft/ft)	Bottom Width (ft)	Side Slope
N Ditch	1600	0.03	0.004	2.5	2 :1
W Ditch	1500	0.03	0.004	1	2.5 :1
SE Ditch	2250	0.03	0.004	4	2 :1

Reach Identifier	Stage (ft)	Flow (cfs)	End Area (sq ft)	Top Width (ft)	Friction Slope (ft/ft)
N Ditch	0.0	0.000	0	2.5	0.004
	0.5	2.823	1.8	4.5	
	1.0	10.529	4.5	6.5	
	2.0	44.338	13	10.5	
	5.0	362.009	62.5	22.5	
	10.0	1995.903	225	42.5	
	20.0	11729.537	850	82.5	
W Ditch	0.0	0.000	0	1	0.004
	0.5	1.596	1.1	3.5	
	1.0	7.344	3.5	6	
	2.0	38.081	12	11	
	5.0	380.858	67.5	26	
	10.0	2298.388	260	51	
	20.0	14215.627	1020	101	
SE Ditch	0.0	0.000	0	4	0.004
	0.5	4.258	2.5	6	
	1.0	14.934	6	8	
	2.0	57.731	16	12	
	5.0	420.520	70	24	
	10.0	2176.707	240	44	
	20.0	12294.240	880	84	

H. Lockley

35107130

Final Cover System Stormwater Runoff
Rogers County, Oklahoma

Structure Description - User Entered

Reach Identifier	Surface Area @ Crest (ac)	Height Above Crest (ft)	Surface Area @ Ht Above (ac)	Pipe Diameter (in)	Head on Pipe (ft)	Weir Length (ft)

H. Lockley

35107130
Final Cover System Stormwater Runoff
Rogers County, Oklahoma
Structure Rating Details - Computed

ATTACHMENT C

STORMWATER QUANTITIES

POND CAPACITY CALCULATIONS	
25 year, 24 hour storm (in)	7
25 year, 24 hour storm (ft)	0.59
*Storm Runoff (ft)	0.53
Area (ac)	48
Area (ft ²)	2,076,941
Rainfall Volume (ft ³)	1,105,971
Rainfall Volume (gal)	8,272,686
**Pond Capacity (gal)	12,768,927
Capacity after storm (gal)	4,496,241

*Derived from the TR-20 output

**Based on maximum elevation of 616 feet

ELEVATION-STORAGE	
Elevation (ft)	Storage (gal)
610	3,251,617
611	4,498,994
612	5,943,580
613	7,501,356
614	9,152,033
615	10,909,245
616	12,768,927

35107130
Final Cover System Stormwater Runoff

Name of printed page file:
TR20.out

STORM 25-Yr

Area or Reach Identifier	Drainage Area (sq mi)	Rain Gage ID or Location	Runoff Amount (in)	Elevation (ft)	Peak Time (hr)	Flow Rate (cfs)	Peak Flow Rate (csm)
Area 4	0.005		4.665		11.93	21.40	4562.70

Line Start Time (hr)	Flow (cfs)	Values @ time increment (cfs)	Flow (cfs)	Values @ time increment (cfs)	Flow (cfs)	Values @ time increment (cfs)	Flow (cfs)	Values @ time increment (cfs)
7.069	0.05	0.05	0.05	0.05	0.05	0.05	0.05	0.05
7.113	0.05	0.05	0.05	0.05	0.05	0.05	0.05	0.05
7.157	0.05	0.05	0.05	0.05	0.06	0.06	0.06	0.06
7.201	0.06	0.06	0.06	0.06	0.06	0.06	0.06	0.06
7.246	0.06	0.06	0.06	0.06	0.06	0.06	0.06	0.06
7.290	0.06	0.06	0.06	0.06	0.06	0.06	0.06	0.06
7.334	0.06	0.06	0.06	0.06	0.06	0.06	0.06	0.06
7.378	0.06	0.06	0.06	0.06	0.06	0.07	0.07	0.07
7.422	0.07	0.07	0.07	0.07	0.07	0.07	0.07	0.07
7.467	0.07	0.07	0.07	0.07	0.07	0.07	0.07	0.07
7.511	0.07	0.07	0.07	0.07	0.07	0.07	0.07	0.07
7.555	0.07	0.07	0.07	0.07	0.07	0.07	0.07	0.07
7.599	0.07	0.07	0.07	0.07	0.07	0.08	0.08	0.08
7.643	0.08	0.08	0.08	0.08	0.08	0.08	0.08	0.08
7.688	0.08	0.08	0.08	0.08	0.08	0.08	0.08	0.08
7.732	0.08	0.08	0.08	0.08	0.08	0.08	0.08	0.08
7.776	0.08	0.08	0.08	0.08	0.08	0.08	0.08	0.08
7.820	0.08	0.08	0.08	0.08	0.09	0.09	0.09	0.09
7.865	0.09	0.09	0.09	0.09	0.09	0.09	0.09	0.09
7.909	0.09	0.09	0.09	0.09	0.09	0.09	0.09	0.09
7.953	0.09	0.09	0.09	0.09	0.09	0.09	0.09	0.09
7.997	0.09	0.09	0.09	0.09	0.09	0.09	0.09	0.09
8.041	0.09	0.10	0.10	0.10	0.10	0.10	0.10	0.10
8.086	0.10	0.10	0.10	0.10	0.10	0.10	0.10	0.10
8.130	0.10	0.10	0.10	0.10	0.10	0.10	0.10	0.10
8.174	0.10	0.11	0.11	0.11	0.11	0.11	0.11	0.11
8.218	0.11	0.11	0.11	0.11	0.11	0.11	0.11	0.11
8.262	0.11	0.11	0.11	0.11	0.12	0.12	0.12	0.12
8.307	0.12	0.12	0.12	0.12	0.12	0.12	0.12	0.12
8.351	0.12	0.12	0.12	0.12	0.12	0.12	0.12	0.12
8.395	0.13	0.13	0.13	0.13	0.13	0.13	0.13	0.13
8.439	0.13	0.13	0.13	0.13	0.13	0.13	0.13	0.13
8.483	0.13	0.13	0.14	0.14	0.14	0.14	0.14	0.14
8.528	0.14	0.14	0.14	0.14	0.14	0.14	0.14	0.14
8.572	0.14	0.14	0.14	0.15	0.15	0.15	0.15	0.15
8.616	0.15	0.15	0.15	0.15	0.15	0.15	0.15	0.15
8.660	0.15	0.15	0.15	0.16	0.16	0.16	0.16	0.16
8.705	0.16	0.16	0.16	0.16	0.16	0.16	0.16	0.16
8.749	0.16	0.16	0.16	0.17	0.17	0.17	0.17	0.17
8.793	0.17	0.17	0.17	0.17	0.17	0.17	0.17	0.17

35107130
Final Cover System Stormwater Runoff

Line Start Time (hr)	Flow (cfs)	Values @ time increment (cfs)	Flow (cfs)	Values @ time increment (cfs)	Flow (cfs)	Values @ time increment (cfs)	Flow (cfs)	Values @ time increment (cfs)
8.837	0.17	0.17	0.17	0.18	0.18	0.18	0.18	0.18
8.881	0.18	0.18	0.18	0.18	0.18	0.18	0.18	0.18

35107130
Final Cover System Stormwater Runoff

Name of printed page file:
TR20.out

(continued)

STORM 25-Yr

Area or Reach Identifier	Drainage Area (sq mi)	Rain Gage ID or Location	Runoff Amount (in)	Elevation (ft)	Peak Flow Time (hr)	Peak Flow Rate (cfs)	Peak Flow Rate (csm)
23.351	0.22	0.22	0.22	0.22	0.22	0.22	0.22
23.395	0.22	0.22	0.22	0.22	0.22	0.22	0.22
23.439	0.22	0.22	0.22	0.22	0.22	0.22	0.22
23.483	0.22	0.22	0.22	0.22	0.22	0.22	0.22
23.528	0.22	0.22	0.22	0.22	0.22	0.22	0.22
23.572	0.22	0.22	0.22	0.22	0.22	0.22	0.22
23.616	0.22	0.22	0.22	0.22	0.22	0.22	0.22
23.660	0.22	0.22	0.22	0.22	0.22	0.22	0.22
23.705	0.22	0.22	0.22	0.22	0.22	0.22	0.22
23.749	0.22	0.22	0.22	0.22	0.22	0.22	0.22
23.793	0.22	0.22	0.22	0.22	0.22	0.22	0.22
23.837	0.22	0.22	0.22	0.22	0.22	0.22	0.22
23.881	0.22	0.22	0.22	0.22	0.22	0.22	0.22
23.926	0.22	0.22	0.22	0.22	0.22	0.22	0.22
23.970	0.22	0.22	0.22	0.22	0.22	0.22	0.22
24.014	0.22	0.22	0.22	0.22	0.22	0.22	0.22
24.058	0.22	0.22	0.22	0.22	0.22	0.21	0.21
24.102	0.21	0.21	0.20	0.20	0.19	0.18	0.17
24.147	0.16	0.14	0.11	0.07			

Area or Reach Identifier	Drainage Area (sq mi)	Rain Gage ID or Location	Runoff Amount (in)	Elevation (ft)	Peak Flow Time (hr)	Peak Flow Rate (cfs)	Peak Flow Rate (csm)
Area 2	0.011		4.674		11.95	46.62	4261.16

Line

Start Time (hr)	Flow (cfs)	Flow (cfs)	Flow (cfs)	Flow (cfs)	Flow (cfs)	Flow (cfs)	Flow (cfs)
6.409	0.05	0.05	0.05	0.05	0.05	0.05	0.06
6.471	0.06	0.06	0.06	0.06	0.06	0.06	0.06

WinTR-20 Version 1.0 Page 23 09/20/2011 10:02

35107130
Final Cover System Stormwater Runoff

Line

Start Time (hr)	Flow (cfs)	Flow (cfs)	Flow (cfs)	Flow (cfs)	Flow (cfs)	Flow (cfs)	Flow (cfs)
6.533	0.06	0.06	0.06	0.06	0.07	0.07	0.07
6.595	0.07	0.07	0.07	0.07	0.07	0.07	0.07
6.657	0.07	0.07	0.08	0.08	0.08	0.08	0.08
6.719	0.08	0.08	0.08	0.08	0.08	0.08	0.08
6.781	0.09	0.09	0.09	0.09	0.09	0.09	0.09
6.843	0.09	0.09	0.09	0.09	0.09	0.10	0.10
6.905	0.10	0.10	0.10	0.10	0.10	0.10	0.10
6.966	0.10	0.10	0.11	0.11	0.11	0.11	0.11
7.028	0.11	0.11	0.11	0.11	0.11	0.11	0.11
7.090	0.12	0.12	0.12	0.12	0.12	0.12	0.12
7.152	0.12	0.12	0.12	0.12	0.13	0.13	0.13
7.214	0.13	0.13	0.13	0.13	0.13	0.13	0.13
7.276	0.13	0.14	0.14	0.14	0.14	0.14	0.14
7.338	0.14	0.14	0.14	0.14	0.14	0.15	0.15
7.400	0.15	0.15	0.15	0.15	0.15	0.15	0.15
7.462	0.15	0.15	0.16	0.16	0.16	0.16	0.16
7.523	0.16	0.16	0.16	0.16	0.16	0.17	0.17

WinTR-55, Version 1.00.08 Page 24 9/20/2011 10:03:28 AM

35107130
Final Cover System Stormwater Runoff

Name of printed page file:
TR20.out

(continued)

STORM 25-Yr

Area or Reach Identifier	Drainage Area (sq mi)	Rain Gage ID or Location	Runoff Amount (in)	Elevation (ft)	Peak Flow Time (hr)	Peak Flow Rate (cfs)	Peak Flow Rate (csm)
22.750	0.54	0.54	0.54	0.54	0.53	0.53	0.53
22.811	0.53	0.53	0.53	0.53	0.53	0.53	0.53
22.873	0.53	0.53	0.53	0.53	0.53	0.53	0.53
22.935	0.53	0.53	0.53	0.53	0.53	0.53	0.53
22.997	0.53	0.53	0.53	0.53	0.53	0.53	0.53
23.059	0.53	0.53	0.53	0.53	0.53	0.53	0.53
23.121	0.53	0.53	0.53	0.53	0.53	0.53	0.53
23.183	0.53	0.53	0.53	0.53	0.52	0.52	0.52
23.245	0.52	0.52	0.52	0.52	0.52	0.52	0.52
23.307	0.52	0.52	0.52	0.52	0.52	0.52	0.52
23.369	0.52	0.52	0.52	0.52	0.52	0.52	0.52
23.430	0.52	0.52	0.52	0.52	0.52	0.52	0.52
23.492	0.52	0.52	0.52	0.52	0.52	0.52	0.52
23.554	0.52	0.52	0.52	0.52	0.52	0.52	0.52
23.616	0.52	0.52	0.52	0.52	0.52	0.52	0.52
23.678	0.51	0.51	0.51	0.51	0.51	0.51	0.51
23.740	0.51	0.51	0.51	0.51	0.51	0.51	0.51
23.802	0.51	0.51	0.51	0.51	0.51	0.51	0.51
23.864	0.51	0.51	0.51	0.51	0.51	0.51	0.51
23.926	0.51	0.51	0.51	0.51	0.51	0.51	0.51
23.987	0.51	0.51	0.51	0.50	0.50	0.49	0.47
24.049	0.45	0.42	0.39	0.35	0.31	0.28	0.24
24.111	0.21	0.18	0.15	0.12	0.11	0.09	0.08
24.173	0.06	0.05					

Area or Reach Identifier	Drainage Area (sq mi)	Rain Gage ID or Location	Runoff Amount (in)	Elevation (ft)	Peak Flow Time (hr)	Peak Flow Rate (cfs)	Peak Flow Rate (csm)
Area 3	0.025		4.675		11.96	105.23	4209.34

Line

Start Time (hr)	Flow (cfs)	Flow (cfs)	Flow (cfs)	Flow (cfs)	Flow (cfs)	Flow (cfs)	Flow (cfs)
6.094	0.05	0.05	0.05	0.06	0.06	0.06	0.06
6.160	0.06	0.07	0.07	0.07	0.07	0.07	0.08
6.225	0.08	0.08	0.08	0.08	0.08	0.09	0.09
6.290	0.09	0.09	0.09	0.10	0.10	0.10	0.10
6.356	0.10	0.11	0.11	0.11	0.11	0.11	0.12
6.421	0.12	0.12	0.12	0.12	0.12	0.13	0.13
6.487	0.13	0.13	0.13	0.14	0.14	0.14	0.14
6.552	0.14	0.15	0.15	0.15	0.15	0.15	0.16
6.618	0.16	0.16	0.16	0.16	0.17	0.17	0.17

35107130
Final Cover System Stormwater Runoff

Line

Start Time (hr)	Flow (cfs)	Flow (cfs)	Flow (cfs)	Flow (cfs)	Flow (cfs)	Flow (cfs)	Flow (cfs)
6.683	0.17	0.17	0.18	0.18	0.18	0.18	0.18
6.748	0.19	0.19	0.19	0.19	0.19	0.20	0.20
6.814	0.20	0.20	0.21	0.21	0.21	0.21	0.21
6.879	0.22	0.22	0.22	0.22	0.22	0.23	0.23
6.945	0.23	0.23	0.23	0.24	0.24	0.24	0.24

35107130
Final Cover System Stormwater Runoff

Name of printed page file:
TR20.out

(continued)

STORM 25-Yr

Area or Reach Identifier	Drainage Area (sq mi)	Rain Gage ID or Location	Runoff Amount (in)	Elevation (ft)	Peak Flow Time (hr)	Peak Flow Rate (cfs)	Peak Flow Rate (csm)
23.837	1.91	1.91	1.91	1.91	1.91	1.91	1.91
23.881	1.90	1.90	1.90	1.90	1.90	1.90	1.90
23.926	1.90	1.90	1.90	1.90	1.90	1.90	1.90
23.970	1.90	1.90	1.90	1.90	1.90	1.90	1.90
24.014	1.89	1.89	1.89	1.89	1.89	1.89	1.89
24.058	1.89	1.88	1.88	1.87	1.86	1.85	1.83
24.102	1.81	1.78	1.75	1.72	1.67	1.63	1.58
24.147	1.52	1.46	1.39	1.33	1.26	1.19	1.11
24.191	1.04	0.97	0.90	0.83	0.76	0.69	0.63
24.235	0.56	0.51	0.45	0.40	0.35	0.31	0.26
24.279	0.22	0.18	0.14	0.08			

Area or Reach Identifier	Drainage Area (sq mi)	Rain Gage ID or Location	Runoff Amount (in)	Elevation (ft)	Peak Flow Time (hr)	Peak Flow Rate (cfs)	Peak Flow Rate (csm)
Area 1	0.022		4.675		11.96	92.21	4214.24

Line

Start Time (hr)	Flow (cfs)	Flow (cfs)	Flow (cfs)	Flow (cfs)	Flow (cfs)	Flow (cfs)	Flow (cfs)
6.129	0.05	0.05	0.05	0.06	0.06	0.06	0.06
6.194	0.06	0.06	0.07	0.07	0.07	0.07	0.07
6.259	0.07	0.08	0.08	0.08	0.08	0.08	0.08
6.324	0.08	0.09	0.09	0.09	0.09	0.09	0.09
6.389	0.10	0.10	0.10	0.10	0.10	0.11	0.11
6.454	0.11	0.11	0.11	0.11	0.12	0.12	0.12
6.519	0.12	0.12	0.12	0.13	0.13	0.13	0.13

WinTR-20 Version 1.0

Page 51

09/20/2011 10:02

35107130
Final Cover System Stormwater Runoff

Line

Start Time (hr)	Flow (cfs)	Flow (cfs)	Flow (cfs)	Flow (cfs)	Flow (cfs)	Flow (cfs)	Flow (cfs)
6.584	0.13	0.13	0.14	0.14	0.14	0.14	0.14
6.649	0.14	0.15	0.15	0.15	0.15	0.15	0.16
6.714	0.16	0.16	0.16	0.16	0.16	0.17	0.17
6.779	0.17	0.17	0.17	0.17	0.18	0.18	0.18
6.844	0.18	0.18	0.19	0.19	0.19	0.19	0.19
6.909	0.19	0.20	0.20	0.20	0.20	0.20	0.21
6.973	0.21	0.21	0.21	0.21	0.21	0.22	0.22
7.038	0.22	0.22	0.22	0.23	0.23	0.23	0.23
7.103	0.23	0.23	0.24	0.24	0.24	0.24	0.24
7.168	0.25	0.25	0.25	0.25	0.25	0.26	0.26
7.233	0.26	0.26	0.26	0.27	0.27	0.27	0.27
7.298	0.27	0.27	0.28	0.28	0.28	0.28	0.28
7.363	0.29	0.29	0.29	0.29	0.29	0.30	0.30
7.428	0.30	0.30	0.30	0.31	0.31	0.31	0.31
7.493	0.31	0.32	0.32	0.32	0.32	0.32	0.33
7.558	0.33	0.33	0.33	0.33	0.34	0.34	0.34
7.623	0.34	0.34	0.34	0.35	0.35	0.35	0.35
7.688	0.35	0.36	0.36	0.36	0.36	0.36	0.37
7.753	0.37	0.37	0.37	0.38	0.38	0.38	0.38
7.818	0.38	0.39	0.39	0.39	0.39	0.39	0.40

WinTR-55, Version 1.00.08

Page 53

9/20/2011 10:03:29 AM

35107130
Final Cover System Stormwater Runoff

Name of printed page file:
TR20.out (continued)

STORM 25-Yr

Area or Reach Identifier	Drainage Area (sq mi)	Rain Gage ID or Location	Runoff Amount (in)	Elevation (ft)	Peak Time (hr)	Flow Rate (cfs)	Rate (csm)
22.190	1.10	1.10	1.10	1.10	1.10	1.10	1.10
22.255	1.10	1.10	1.10	1.09	1.09	1.09	1.09

WinTR-20 Version 1.0 Page 67 09/20/2011 10:02

35107130
Final Cover System Stormwater Runoff

Line Start Time (hr)	Flow Values @ time increment of 0.009 hr						
	(cfs)	(cfs)	(cfs)	(cfs)	(cfs)	(cfs)	(cfs)
22.320	1.09	1.09	1.09	1.09	1.09	1.09	1.09
22.385	1.09	1.09	1.09	1.09	1.09	1.09	1.09
22.450	1.09	1.09	1.09	1.09	1.09	1.09	1.08
22.515	1.08	1.08	1.08	1.08	1.08	1.08	1.08
22.580	1.08	1.08	1.08	1.08	1.08	1.08	1.08
22.645	1.08	1.08	1.08	1.08	1.08	1.08	1.08
22.710	1.08	1.08	1.08	1.07	1.07	1.07	1.07
22.775	1.07	1.07	1.07	1.07	1.07	1.07	1.07
22.840	1.07	1.07	1.07	1.07	1.07	1.07	1.07
22.905	1.07	1.07	1.07	1.07	1.07	1.07	1.07
22.970	1.07	1.07	1.06	1.06	1.06	1.06	1.06
23.035	1.06	1.06	1.06	1.06	1.06	1.06	1.06
23.100	1.06	1.06	1.06	1.06	1.06	1.06	1.06
23.165	1.06	1.06	1.06	1.06	1.06	1.06	1.05
23.230	1.05	1.05	1.05	1.05	1.05	1.05	1.05
23.295	1.05	1.05	1.05	1.05	1.05	1.05	1.05
23.360	1.05	1.05	1.05	1.05	1.05	1.05	1.05
23.425	1.05	1.05	1.04	1.04	1.04	1.04	1.04
23.490	1.04	1.04	1.04	1.04	1.04	1.04	1.04
23.555	1.04	1.04	1.04	1.04	1.04	1.04	1.04
23.620	1.04	1.04	1.04	1.04	1.03	1.03	1.03
23.685	1.03	1.03	1.03	1.03	1.03	1.03	1.03
23.750	1.03	1.03	1.03	1.03	1.03	1.03	1.03
23.815	1.03	1.03	1.03	1.03	1.03	1.03	1.03
23.880	1.02	1.02	1.02	1.02	1.02	1.02	1.02
23.945	1.02	1.02	1.02	1.02	1.02	1.02	1.02
24.010	1.02	1.02	1.02	1.02	1.02	1.01	1.01
24.075	1.00	0.98	0.97	0.94	0.90	0.86	0.81
24.140	0.76	0.70	0.64	0.58	0.51	0.45	0.40
24.205	0.35	0.30	0.26	0.22	0.19	0.16	0.13
24.270	0.09	0.05					

Area or Reach Identifier	Drainage Area (sq mi)	Rain Gage ID or Location	Runoff Amount (in)	Elevation (ft)	Peak Time (hr)	Flow Rate (cfs)	Rate (csm)
OUTLET	0.063		4.670		12.06	249.96	3998.65

Line Start Time (hr)	Flow Values @ time increment of 0.006 hr						
	(cfs)	(cfs)	(cfs)	(cfs)	(cfs)	(cfs)	(cfs)
6.532	0.07	0.09	0.10	0.16	0.21	0.24	0.26
6.576	0.28	0.29	0.30	0.31	0.31	0.32	0.32
6.620	0.33	0.33	0.33	0.34	0.34	0.34	0.35
6.665	0.35	0.35	0.36	0.36	0.36	0.37	0.37
6.709	0.37	0.37	0.38	0.38	0.38	0.39	0.39

WinTR-55, Version 1.00.08 Page 70 9/20/2011 10:03:29 AM

35107130
Final Cover System Stormwater Runoff

Name of printed page file:
TR20.out

(continued)

STORM 25-Yr

Area or Reach Identifier	Drainage Area (sq mi)	Rain Gage ID or Location	Runoff Amount (in)	Elevation (ft)	Peak Flow Time (hr)	Peak Flow Rate (cfs)	Rate (csm)
24.083	2.85	2.82	2.79	2.75	2.70	2.64	2.58
24.128	2.50	2.42	2.33	2.23	2.13	2.03	1.92
24.172	1.80	1.69	1.58	1.47	1.36	1.25	1.15
24.216	1.05	0.95	0.86	0.78	0.70	0.62	0.55
24.260	0.48	0.41	0.34	0.27	0.20	0.14	0.08

STORM 100-Yr

Area or Reach Identifier	Drainage Area (sq mi)	Rain Gage ID or Location	Runoff Amount (in)	Elevation (ft)	Peak Flow Time (hr)	Peak Flow Rate (cfs)	Rate (csm)
Area 4	0.005		6.248		11.93	28.30	6034.68

Line

Start Time (hr)	Flow (cfs)	Flow (cfs)	Flow (cfs)	Flow (cfs)	Flow (cfs)	Flow (cfs)	Flow (cfs)
5.954	0.05	0.05	0.05	0.05	0.05	0.05	0.05
5.999	0.05	0.05	0.05	0.05	0.05	0.05	0.05

WinTR-20 Version 1.0

Page 76

09/20/2011 10:02

35107130
Final Cover System Stormwater Runoff

Line

Start Time (hr)	Flow (cfs)	Flow (cfs)	Flow (cfs)	Flow (cfs)	Flow (cfs)	Flow (cfs)	Flow (cfs)
6.043	0.05	0.06	0.06	0.06	0.06	0.06	0.06
6.087	0.06	0.06	0.06	0.06	0.06	0.06	0.06
6.131	0.06	0.06	0.06	0.06	0.06	0.06	0.06
6.176	0.06	0.06	0.06	0.06	0.06	0.06	0.06
6.220	0.06	0.06	0.06	0.07	0.07	0.07	0.07
6.264	0.07	0.07	0.07	0.07	0.07	0.07	0.07
6.308	0.07	0.07	0.07	0.07	0.07	0.07	0.07
6.352	0.07	0.07	0.07	0.07	0.07	0.07	0.07
6.397	0.07	0.07	0.07	0.08	0.08	0.08	0.08
6.441	0.08	0.08	0.08	0.08	0.08	0.08	0.08
6.485	0.08	0.08	0.08	0.08	0.08	0.08	0.08
6.529	0.08	0.08	0.08	0.08	0.08	0.08	0.08
6.573	0.08	0.08	0.08	0.09	0.09	0.09	0.09
6.618	0.09	0.09	0.09	0.09	0.09	0.09	0.09
6.662	0.09	0.09	0.09	0.09	0.09	0.09	0.09
6.706	0.09	0.09	0.09	0.09	0.09	0.09	0.09
6.750	0.09	0.09	0.10	0.10	0.10	0.10	0.10
6.794	0.10	0.10	0.10	0.10	0.10	0.10	0.10
6.839	0.10	0.10	0.10	0.10	0.10	0.10	0.10
6.883	0.10	0.10	0.10	0.10	0.10	0.10	0.10
6.927	0.10	0.11	0.11	0.11	0.11	0.11	0.11
6.971	0.11	0.11	0.11	0.11	0.11	0.11	0.11
7.016	0.11	0.11	0.11	0.11	0.11	0.11	0.11
7.060	0.11	0.11	0.11	0.11	0.11	0.11	0.11
7.104	0.12	0.12	0.12	0.12	0.12	0.12	0.12
7.148	0.12	0.12	0.12	0.12	0.12	0.12	0.12
7.192	0.12	0.12	0.12	0.12	0.12	0.12	0.12
7.237	0.12	0.12	0.12	0.12	0.13	0.13	0.13
7.281	0.13	0.13	0.13	0.13	0.13	0.13	0.13

WinTR-55, Version 1.00.08

Page 79

9/20/2011 10:03:29 AM

35107130
Final Cover System Stormwater Runoff

Name of printed page file:
TR20.out

(continued)

STORM 100-Yr

Area or Reach Identifier	Drainage Area (sq mi)	Rain Gage ID or Location	Runoff Amount (in)	Elevation (ft)	Peak Flow Time (hr)	Peak Flow Rate (cfs)	Peak Flow Rate (csm)
22.689	0.68	0.68	0.68	0.68	0.68	0.68	0.68
22.751	0.68	0.68	0.68	0.68	0.68	0.68	0.68
22.813	0.68	0.68	0.68	0.68	0.68	0.68	0.68
22.874	0.68	0.68	0.68	0.68	0.68	0.68	0.68
22.936	0.68	0.68	0.68	0.68	0.68	0.68	0.67
22.998	0.67	0.67	0.67	0.67	0.67	0.67	0.67
23.060	0.67	0.67	0.67	0.67	0.67	0.67	0.67
23.122	0.67	0.67	0.67	0.67	0.67	0.67	0.67
23.184	0.67	0.67	0.67	0.67	0.67	0.67	0.67
23.246	0.67	0.67	0.67	0.67	0.67	0.67	0.67
23.308	0.67	0.67	0.67	0.67	0.67	0.67	0.66
23.370	0.66	0.66	0.66	0.66	0.66	0.66	0.66
23.432	0.66	0.66	0.66	0.66	0.66	0.66	0.66
23.493	0.66	0.66	0.66	0.66	0.66	0.66	0.66
23.555	0.66	0.66	0.66	0.66	0.66	0.66	0.66
23.617	0.66	0.66	0.66	0.66	0.66	0.66	0.66
23.679	0.66	0.65	0.65	0.65	0.65	0.65	0.65
23.741	0.65	0.65	0.65	0.65	0.65	0.65	0.65
23.803	0.65	0.65	0.65	0.65	0.65	0.65	0.65
23.865	0.65	0.65	0.65	0.65	0.65	0.65	0.65
23.927	0.65	0.65	0.65	0.65	0.65	0.65	0.65

WinTR-20 Version 1.0

Page 106

09/20/2011 10:02

35107130
Final Cover System Stormwater Runoff

Line Start Time (hr)	Flow Values @ time increment of 0.009 hr						
(hr)	(cfs)	(cfs)	(cfs)	(cfs)	(cfs)	(cfs)	(cfs)
23.989	0.65	0.65	0.64	0.64	0.63	0.62	0.60
24.050	0.57	0.53	0.49	0.44	0.39	0.34	0.30
24.112	0.26	0.22	0.18	0.15	0.13	0.11	0.09
24.174	0.08	0.07	0.06				

Area or Reach Identifier	Drainage Area (sq mi)	Rain Gage ID or Location	Runoff Amount (in)	Elevation (ft)	Peak Flow Time (hr)	Peak Flow Rate (cfs)	Peak Flow Rate (csm)
Area 3	0.025		6.256		11.96	139.33	5573.15

Line Start Time (hr)	Flow Values @ time increment of 0.009 hr						
(hr)	(cfs)	(cfs)	(cfs)	(cfs)	(cfs)	(cfs)	(cfs)
5.164	0.05	0.05	0.05	0.06	0.06	0.06	0.06
5.229	0.07	0.07	0.07	0.07	0.08	0.08	0.08
5.295	0.08	0.08	0.09	0.09	0.09	0.09	0.10
5.360	0.10	0.10	0.10	0.11	0.11	0.11	0.11
5.425	0.11	0.12	0.12	0.12	0.12	0.13	0.13
5.491	0.13	0.13	0.14	0.14	0.14	0.14	0.15
5.556	0.15	0.15	0.15	0.16	0.16	0.16	0.16
5.622	0.17	0.17	0.17	0.17	0.18	0.18	0.18
5.687	0.18	0.19	0.19	0.19	0.19	0.20	0.20
5.753	0.20	0.20	0.21	0.21	0.21	0.21	0.22
5.818	0.22	0.22	0.22	0.23	0.23	0.23	0.23
5.883	0.24	0.24	0.24	0.24	0.25	0.25	0.25
5.949	0.25	0.26	0.26	0.26	0.27	0.27	0.27

WinTR-55, Version 1.00.08

Page 110

9/20/2011 10:03:30 AM

35107130
Final Cover System Stormwater Runoff

Name of printed page file:
TR20.out (continued)

STORM 100-Yr

Area or Reach Identifier	Drainage Area (sq mi)	Rain Gage ID or Location	Runoff Amount (in)	Elevation (ft)	Peak Flow Time (hr)	Peak Flow Rate (cfs)	Peak Flow Rate (csm)
23.418	2.47	2.47	2.47	2.47	2.47	2.47	2.47
23.462	2.47	2.47	2.46	2.46	2.46	2.46	2.46
23.506	2.46	2.46	2.46	2.46	2.46	2.46	2.46
23.550	2.46	2.46	2.46	2.45	2.45	2.45	2.45
23.594	2.45	2.45	2.45	2.45	2.45	2.45	2.45
23.639	2.45	2.45	2.45	2.45	2.45	2.44	2.44
23.683	2.44	2.44	2.44	2.44	2.44	2.44	2.44
23.727	2.44	2.44	2.44	2.44	2.44	2.43	2.43

WinTR-20 Version 1.0 Page 129 09/20/2011 10:02

35107130
Final Cover System Stormwater Runoff

Line

Start Time (hr)	Flow Values @ time increment of 0.006 hr						
(cfs)	(cfs)	(cfs)	(cfs)	(cfs)	(cfs)	(cfs)	(cfs)
23.771	2.43	2.43	2.43	2.43	2.43	2.43	2.43
23.816	2.43	2.43	2.43	2.43	2.43	2.43	2.43
23.860	2.42	2.42	2.42	2.42	2.42	2.42	2.42
23.904	2.42	2.42	2.42	2.42	2.42	2.42	2.41
23.948	2.41	2.41	2.41	2.41	2.41	2.41	2.41
23.992	2.41	2.41	2.41	2.41	2.41	2.41	2.41
24.037	2.41	2.40	2.40	2.40	2.39	2.39	2.38
24.081	2.36	2.34	2.32	2.29	2.26	2.22	2.17
24.125	2.11	2.05	1.98	1.90	1.83	1.74	1.65
24.169	1.57	1.48	1.38	1.29	1.20	1.12	1.03
24.213	0.95	0.86	0.78	0.71	0.64	0.57	0.51
24.258	0.45	0.40	0.35	0.30	0.26	0.22	0.18
24.302	0.14	0.09	0.05				

Area or Reach Identifier	Drainage Area (sq mi)	Rain Gage ID or Location	Runoff Amount (in)	Elevation (ft)	Peak Flow Time (hr)	Peak Flow Rate (cfs)	Peak Flow Rate (csm)
Area 1	0.022		6.256		11.96	122.13	5581.58

Line

Start Time (hr)	Flow Values @ time increment of 0.009 hr						
(cfs)	(cfs)	(cfs)	(cfs)	(cfs)	(cfs)	(cfs)	(cfs)
5.199	0.05	0.05	0.06	0.06	0.06	0.06	0.06
5.264	0.07	0.07	0.07	0.07	0.07	0.08	0.08
5.329	0.08	0.08	0.08	0.09	0.09	0.09	0.09
5.394	0.09	0.10	0.10	0.10	0.10	0.10	0.11
5.459	0.11	0.11	0.11	0.11	0.12	0.12	0.12
5.524	0.12	0.12	0.13	0.13	0.13	0.13	0.14
5.589	0.14	0.14	0.14	0.14	0.15	0.15	0.15
5.654	0.15	0.15	0.16	0.16	0.16	0.16	0.17
5.719	0.17	0.17	0.17	0.17	0.18	0.18	0.18
5.784	0.18	0.19	0.19	0.19	0.19	0.19	0.20
5.849	0.20	0.20	0.20	0.21	0.21	0.21	0.21
5.914	0.21	0.22	0.22	0.22	0.22	0.23	0.23
5.979	0.23	0.23	0.23	0.24	0.24	0.24	0.24
6.044	0.25	0.25	0.25	0.25	0.26	0.26	0.26
6.109	0.26	0.26	0.27	0.27	0.27	0.27	0.28
6.174	0.28	0.28	0.28	0.29	0.29	0.29	0.29
6.238	0.30	0.30	0.30	0.30	0.30	0.31	0.31

35107130
Final Cover System Stormwater Runoff

Name of printed page file:
TR20.out

(continued)

STORM 100-Yr

Area or Reach Identifier	Drainage Area (sq mi)	Rain Gage ID or Location	Runoff Amount (in)	Elevation (ft)	Peak Time (hr)	Flow Rate (cfs)	Rate (csm)
OUTLET	0.063		6.251		12.05	331.00	5295.22

Line Start Time (hr)	Flow (cfs)	Values @ time increment (cfs)	Flow (cfs)	Values @ time increment (cfs)	Flow (cfs)	Values @ time increment (cfs)	Flow (cfs)	Values @ time increment (cfs)
5.544	0.06	0.08	0.15	0.20	0.23	0.26	0.28	
5.588	0.29	0.30	0.31	0.32	0.33	0.33	0.34	
5.632	0.34	0.35	0.35	0.36	0.36	0.36	0.37	
5.677	0.37	0.37	0.38	0.38	0.39	0.39	0.39	
5.721	0.40	0.40	0.41	0.41	0.41	0.42	0.42	
5.765	0.43	0.43	0.43	0.44	0.44	0.44	0.45	
5.809	0.45	0.46	0.46	0.46	0.47	0.47	0.48	
5.853	0.48	0.48	0.49	0.49	0.50	0.50	0.50	
5.898	0.51	0.51	0.52	0.52	0.52	0.53	0.53	
5.942	0.54	0.54	0.54	0.55	0.55	0.56	0.56	
5.986	0.56	0.57	0.57	0.58	0.58	0.58	0.59	
6.030	0.59	0.60	0.60	0.60	0.61	0.61	0.62	
6.074	0.62	0.63	0.63	0.63	0.64	0.64	0.65	
6.119	0.65	0.65	0.66	0.66	0.67	0.67	0.67	
6.163	0.68	0.68	0.69	0.69	0.70	0.70	0.70	
6.207	0.71	0.71	0.72	0.72	0.73	0.73	0.73	
6.251	0.74	0.74	0.75	0.75	0.75	0.76	0.76	
6.296	0.77	0.77	0.78	0.78	0.78	0.79	0.79	
6.340	0.80	0.80	0.81	0.81	0.81	0.82	0.82	
6.384	0.83	0.83	0.84	0.84	0.84	0.85	0.85	
6.428	0.86	0.86	0.87	0.87	0.87	0.88	0.88	
6.472	0.89	0.89	0.90	0.90	0.90	0.91	0.91	
6.517	0.92	0.92	0.93	0.93	0.94	0.94	0.94	
6.561	0.95	0.95	0.96	0.96	0.97	0.97	0.97	
6.605	0.98	0.98	0.99	0.99	1.00	1.00	1.01	
6.649	1.01	1.01	1.02	1.02	1.03	1.03	1.04	
6.693	1.04	1.05	1.05	1.05	1.06	1.06	1.07	
6.738	1.07	1.08	1.08	1.09	1.09	1.10	1.10	
6.782	1.10	1.11	1.11	1.12	1.12	1.13	1.13	
6.826	1.14	1.14	1.14	1.15	1.15	1.16	1.16	
6.870	1.17	1.17	1.18	1.18	1.19	1.19	1.20	
6.914	1.20	1.20	1.21	1.21	1.22	1.22	1.23	
6.959	1.23	1.24	1.24	1.25	1.25	1.25	1.26	
7.003	1.26	1.27	1.27	1.28	1.28	1.29	1.29	
7.047	1.30	1.30	1.31	1.31	1.32	1.32	1.32	

WinTR-20 Version 1.0

Page 148

09/20/2011 10:02

35107130
Final Cover System Stormwater Runoff

Line Start Time (hr)	Flow (cfs)	Values @ time increment (cfs)	Flow (cfs)	Values @ time increment (cfs)	Flow (cfs)	Values @ time increment (cfs)	Flow (cfs)	Values @ time increment (cfs)
7.091	1.33	1.33	1.34	1.34	1.35	1.35	1.36	
7.136	1.36	1.37	1.37	1.38	1.38	1.39	1.39	
7.180	1.39	1.40	1.40	1.41	1.41	1.42	1.42	

WinTR-55, Version 1.00.08

Page 153

9/20/2011 10:03:31 AM

35107130
Final Cover System Stormwater Runoff

Name of printed page file:
TR20.out (continued)

STORM 100-Yr

Area or Reach Identifier	Drainage Area (sq mi)	Rain Gage ID or Location	Runoff Amount (in)	Elevation (ft)	Peak Time (hr)	Peak Flow Rate (cfs)	Peak Flow Rate (csm)
--------------------------	-----------------------	--------------------------	--------------------	----------------	----------------	----------------------	----------------------

WinTR-20 Version 1.0

Page 156

09/20/2011 10:02

35107130
Final Cover System Stormwater Runoff

Area or Reach Identifier	Drainage Area (sq mi)	Alternate	Peak Flow by Storm				
			25-Yr (cfs)	100-Yr (cfs)	(cfs)	(cfs)	(cfs)
Area 1	0.02		92.2	122.1			
Area 2	0.01		46.6	61.7			
Area 3	0.03		105.2	139.3			
Area 4	0.469E-02		21.4	28.3			
N Ditch	0.02		92.2	122.1			
DOWNSTREAM			89.2	118.0			
W Ditch	0.469E-02		21.4	28.3			
DOWNSTREAM			20.0	26.5			
SE Ditch	0.04		167.2	222.0			
DOWNSTREAM			161.7	214.2			
OUTLET	0.06		250.0	331.0			

ATTACHMENT D

OPDES PERMIT NO. OK0034380

**AUTHORIZATION TO DISCHARGE UNDER
THE OKLAHOMA POLLUTANT DISCHARGE ELIMINATION SYSTEM**

Permit Number: OK0034380 Facility ID No.: I-66000010

In compliance with the provisions of the Clean Water Act (33 U.S.C. 125 et seq.), hereinafter called the "Act," and with the provisions of the Oklahoma Pollutant Discharge Elimination System Act (OPDES Act) 27A O.S. §2-6-201 et seq., and the rules of the Oklahoma Department of Environmental Quality promulgated thereunder;

Public Service Company of Oklahoma (PSO)
(Northeastern Generating Station)
P.O. Box 201
Tulsa, OK 74102-0201

is authorized to discharge from a steam electric generating facility, located:

One mile southeast of the Town of Oologah,
at the intersection of U.S. Hwy 169 and State Hwy 88,
in the NW¼, NW¼, Sect 2, the N½ and SW¼ Sect 3, and the E½, Sect 4, T22N,
R15EIM, and in the E½, E½, Sect 33 and all of Sect 34, T23N, R15EIM,
Rogers County, Oklahoma

to receiving waters: the **Verdigris River** (WBID OK121500030010) in stream segment 121500 of the Middle Arkansas River Basin, from two outfalls:

Outfall 004

Latitude N 36° 25' 18", Longitude W 95° 40' 55"
NE¼, NW¼, NW¼, Sect 2, Township 22N, Range 15EIM,
Rogers County, Oklahoma;

Outfall 005

Latitude N 36° 25' 07", Longitude W 95° 41' 26"
NE¼, SW¼, NE¼, Sect 3, Township 22N, Range 15EIM,
Rogers County, Oklahoma;

and from four internal monitoring points:

Internal Monitoring Point 101

Latitude N 36° 25' 51", Longitude W 95° 41' 50"
SE¼, SE¼, NW¼, Sect 34, Township 23N, Range 15EIM,
Rogers County, Oklahoma;

Internal Monitoring Point 102

Latitude N 36° 25' 25", Longitude W 95° 42' 19"
SE¼, SE¼, SE¼, Sect 33, Township 23N, Range 15EIM,
Rogers County, Oklahoma;

Internal Monitoring Point 103

Latitude N 36° 25' 28", Longitude W 95° 41' 49"
SE¼, SE¼, SW¼, Sect 34, Township 23N, Range 15E1M,
Rogers County, Oklahoma

Internal Monitoring Point 104

Latitude N 36° 25' 39.6", Longitude W 95° 42' 34.8"
SE¼, SE¼, SE¼, Sect 33, Township 23N, Range 15E1M,
Rogers County, Oklahoma

The above-referenced facility is also authorized to retain wastewater in one flow-through surface impoundment (F01) and one total retention surface impoundment (T01), and to land apply wastewater to facility haul roads (collectively designated as site L01), as described in the Appendix.

Discharges and maintenance of surface impoundments shall be in accordance with effluent limitations, monitoring requirements and other conditions set forth in Parts I, II, III, and IV hereof.

Issuance of this permit in no way or in any respect affects the permittee's civil or criminal responsibility regarding disposal and/or discharges of wastewater, except with respect to the permittee's legal responsibility under the OPDES Act and Department Rules.

This permit replaces and supersedes OPDES Permit No. OK0034380, which became effective October 1, 1999.

This permit shall become effective on December 15, 2006.

This permit and the authorization to discharge shall expire at midnight on December 14, 2011.

This is to certify that the wastewater discharges set forth in this permit comply with the requirements of Oklahoma's Water Quality Standards, as amended, provided the permittee does not exceed the effluent limitations set forth in this permit.

Issued this 13th day of December, 2006.

For the Oklahoma Department of Environmental Quality,

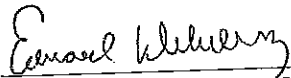

Edward Dührberg, P.E., Manager
Industrial Permits Section
Water Quality Division

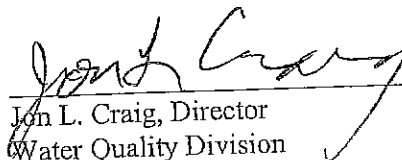

Jon L. Craig, Director
Water Quality Division

APPENDIX 3: PLAN REVIEW LOG

Plan Review and Changes in Facility Configuration

Scheduled reviews and Plan amendments shall be recorded in the Plan Review Log below. This log must be completed even if no amendment is made to the Plan as a result of the review.

By	Date	Amendment Description	P.E. certification required?	P.E. Name	Licensing State: Registration No.
Terracon Consultants	10/16/2016	Initial Plan	Yes	F. Owen Carpenter	Oklahoma P.E. No. 23514
Terracon Consultants	09/10/2021	Five-year review	Yes	F. Owen Carpenter	Oklahoma P.E. No. 23514

APPENDIX 4: PROFESSIONAL ENGINEER CERTIFICATION PAGE

Professional Engineer Certification Page

The undersigned licensed Professional Engineer (P.E.) attests that this Run-on and Run-off Control Plan has been revised in accordance with good engineering practice, including consideration of applicable industry standards. It is the opinion of the undersigned that this Run-on and Run-off Control Plan meets the requirements of OAC 252:517-13-2. This certification in no way relieves the owner or operator of the facility of his/her duty to fully implement this Plan.

Engineer: F. Owen Carpenter, P.E. P.G.
Registration
Number: 23514 (Expires 31-OCT-21)
State: Oklahoma
Date: September 17, 2021



Expires 31/Oct/21

P.E. certification is required for the original Plan and Plan reviews and amendments.